CULTURAL LANDSCAPE INVENTORY:
SHELLROCK MOUNTAIN TO RUTHTON POINT

HISTORIC COLUMBIA RIVER HIGHWAY



Prepared By:
Danae Davison
Barbara Knapp

Prepared For:
Oregon State Department of Transportation

January 2010

Table of Contents

Executive Summary	1
History	13
Inventory	20
Inventory Results.....	21
Shellrock Mountain.....	41
Lindsey Creek	48
Starvation Creek.....	54
Viento.....	59
Mitchell Point.....	65
Mitchell Point East.....	73
Ruthton Point	78
Ruthton Park.....	78
Inventory Summary	87
Further Research Needs.....	87
Appendix 1. Data Forms and Data Dictionary	89
Bibliography	99

List of Figures

Figure 1. Columbia Gorge physiographic context.....	2
Figure 2. Climate zones within the Columbia Gorge.....	2
Figure 3. Columbia Gorge.....	4
Figure 4. Segments of Historic highway inventoried.....	4
Figure 5. G.L.O. Survey Lindsey Creek area, 1881.....	13
Figure 6. Bridge Designs.....	16
Figure 7. Guard rail types.....	32
Figure 8. Shellrock Mountain, 1939 aerial photograph.....	41
Figure 9. Shellrock Mountain, west end. 2003 aerial photograph.....	42
Figure 10. Shellrock Mountain, center section, 2003 aerial photograph.....	42
Figure 11. Shellrock Mountain, east end, 2003 aerial photograph.....	43
Figure 12. Lindsey Creek, 1939 aerial photograph.....	48
Figure 13. West end Lindsey Creek Segment, 2003 aerial photograph.....	49
Figure 14. East end of Lindsey Creek Segment, 2003 aerial photograph.....	49
Figure 15. Starvation Creek Segment, 1939 aerial photograph.....	54
Figure 16. Map of features, Starvation Creek Segment. Aerial photo from 2003.....	55
Figure 17. Viento Segments, 1939 aerial photograph.....	59
Figure 19. Viento features, 2003 aerial photograph.....	60
Figure 20. Viento segments 2 and 3, 2003 aerial photograph.....	61
Figure 21. Viento segment 4, 2003 aerial photograph.....	61
Figure 22. Perham Creek to Mitchell Point, 1939 aerial photograph.....	65
Figure 23. Mitchell Point Segment 1, Perham Creek, 2003 aerial photograph.....	66
Figure 24. Mitchell Point Segment 2, west end of Segment 3, 2003 aerial photograph.....	66
Figure 25. Mitchell Point Segment 3, 2003 aerial photograph.....	67
Figure 26. Mitchell Point East, 1939 aerial photograph.....	73
Figure 27. Mitchell Point East, west end, 2003 aerial photograph.....	74
Figure 28. Mitchell Point East, east end, 2003 aerial photograph.....	74
Figure 29. Ruthton Point, 1939 aerial photograph.....	78
Figure 30. Ruthton Point, 2003 aerial photograph.....	79
Figure 31. Ruthton Park, Ruthton Segment 2, 2003 aerial photograph.....	79
Figure 32. Ruthton Park, Ruthton Segment 2, 1939 aerial photograph.....	80

Acknowledgements

This project could not have been completed without the substantial assistance and support of Mark Davison (Oregon State Parks and Recreation Department), Kristen Stallman (Oregon Department of Transportation), Robert Hadlow (Oregon Department of Transportation), and Linda Dodd (Oregon Department of Transportation).

Executive Summary

This document constitutes the final report on the Historic Columbia River Highway Cultural Landscape Inventory (CLI). The CLI was performed as part of the Historic Columbia River Highway Milepost 2016 Reconnection Projects, which will complete the final 12 miles of the Historic Columbia River Highway State Trail between Wyeth and Hood River, Oregon. The CLI was funded by the Oregon State Department of Transportation and initiated in October 2009.

Introduction to the Cultural Landscape Inventory

A Cultural Landscape Inventory (CLI) is a standard tool developed by the National Park Service for documenting historically significant landscapes. It provides a systematic, detailed description of the physical elements of the landscape, and provides the basis for further research and management.

The CLI records information on individual features of the landscape, defined as the “smallest physical unit that contributes to the significance of the landscape and can be managed as an individual unit” (Page 2001). Retaining walls, vistas, rock cuts, and wayside fountains are examples of features found on the Historic Columbia River Highway. The information collected includes the location, details of materials and construction, and current condition of each feature. The CLI may also inventory existing non-historic features of the landscape, and evaluate their compatibility with the historic features.

The CLI is a multi-step process, with each step corresponding to a specific degree of detail. For each level, additional information is collected, previous information is refined, and further research needs are evaluated. The information collected is entered into a database, and used to generate a report that includes text, maps, and photographs (Page 2001).

The CLI involves historical research as well as fieldwork to relocate and describe historic features. This research provides a basis for evaluating the current condition of features and their contribution to communicating the significance and history of the landscape. This research is typically limited to secondary sources.

The CLI has a number of uses. It assists managers in planning, programming, budgeting, prioritizing and tracking goals for historic landscapes. It provides the documentation necessary for a formal analysis of significance and integrity for the entire landscape based on its component landscapes and features. A CLI generally does not include treatment recommendations, maintenance planning, or design guidelines. However, the CLI provides the information needed for a Cultural Landscape Report (CLR) or other management documents which address those needs.

Landscape Description

The Historic Columbia River Highway (HCRH) is a linear landscape extending 73 miles from Troutdale to The Dalles, Oregon, through the Columbia River gorge. Built between 1913 and 1922, it was the first scenic highway constructed for automobiles in the United States. The highway was designed to protect, enhance and reveal the outstanding scenery of the Columbia River gorge. It was an important precedent for later National Park Service (NPS) and other scenic roadways, and one of the earliest examples of modern techniques for automobile road building on cliff faces. The route was the first complete east-west road through the gorge connecting Portland with eastern Oregon and the Columbia Basin, and the first major paved road in the Pacific Northwest (ODOT 1983). The HCRH was listed on the National Register of Historic Places in 1983 as a National Historic District. In 2000, the most intact portions of the highway were further distinguished as a National Historic Landmark District.

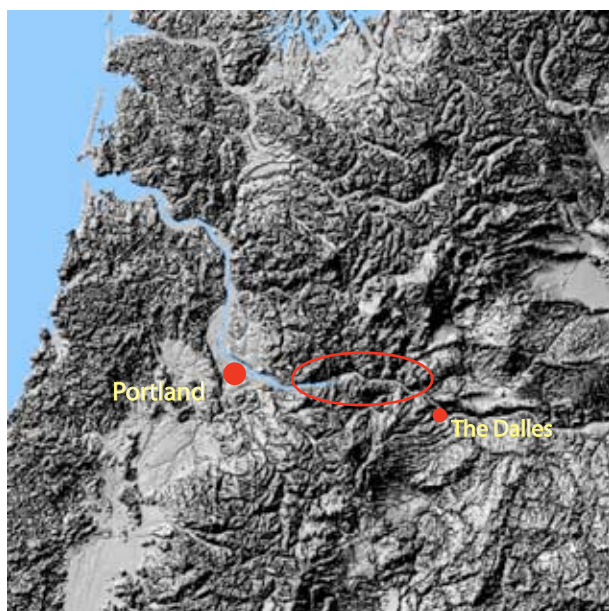

Figure 1. Columbia Gorge physiographic context

Regional Context

The Columbia River gorge cuts through the

volcanic Cascade Range from the city of The Dalles west to Troutdale, Oregon. It was formed by a combination of volcanic activity and repeated cataclysmic floods 13,000 - 15,000 years ago (Alt 2001). The gorge is characterized by basalt cliffs 1,500 to 3,000 feet high, topped by hanging valleys pouring numerous waterfalls into the river; steep, unstable rocky slopes; and gravel flats on the river bottom lands. The highest concentration of waterfalls is on the south side of the river. Most of these falls are found between Troutdale and Dodson.

The climate and vegetation of the Gorge form a gradient from the dry rain shadow of the Cascades on the east to the more humid western side of the mountains, reaching a peak average rainfall in the gorge itself. Average rainfall on the west side of the Cascades is 42 inches per year, while near The Dalles rainfall averages only 14 inches per year (Fig. 2). The physiography of the gorge itself has local climate effects, caused by its high winds, micro-climates found in side canyons, and the vertical climatic gradient of the mountains. These variations produce a unique and varied flora, with many endemic and

Figure 2. Climate zones within the Columbia Gorge, from 70 to 80 inches of rain per year at Cascade Locks to less than 30 inches per year at Hood River. Created from National Atlas. Opposite page: project area map, courtesy of HAER. Columbia River Highway Project 1981

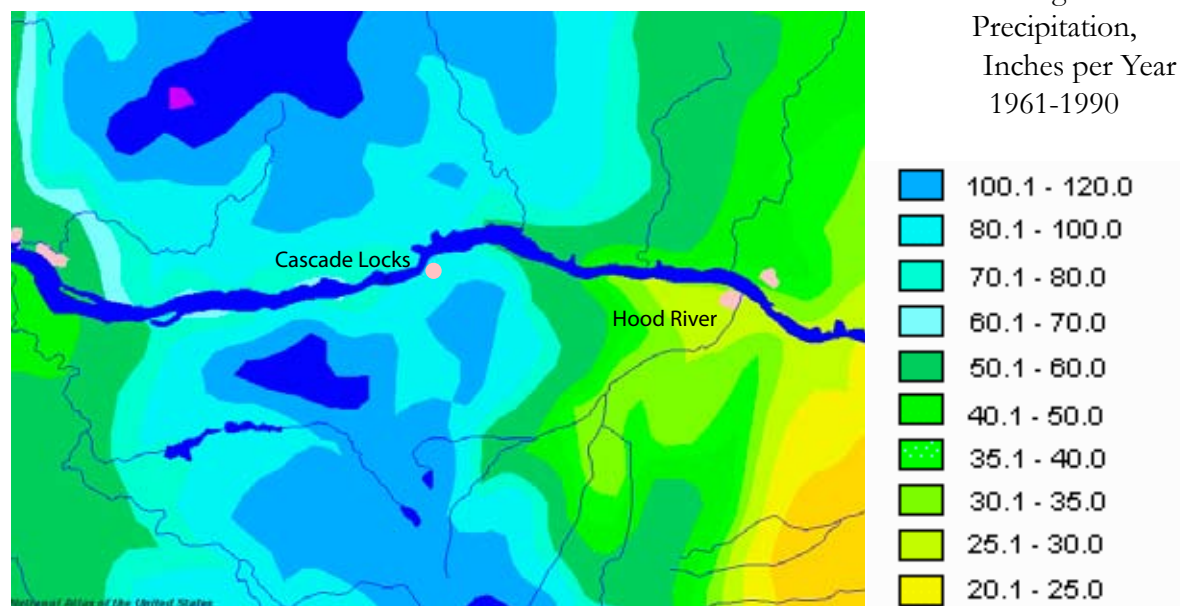

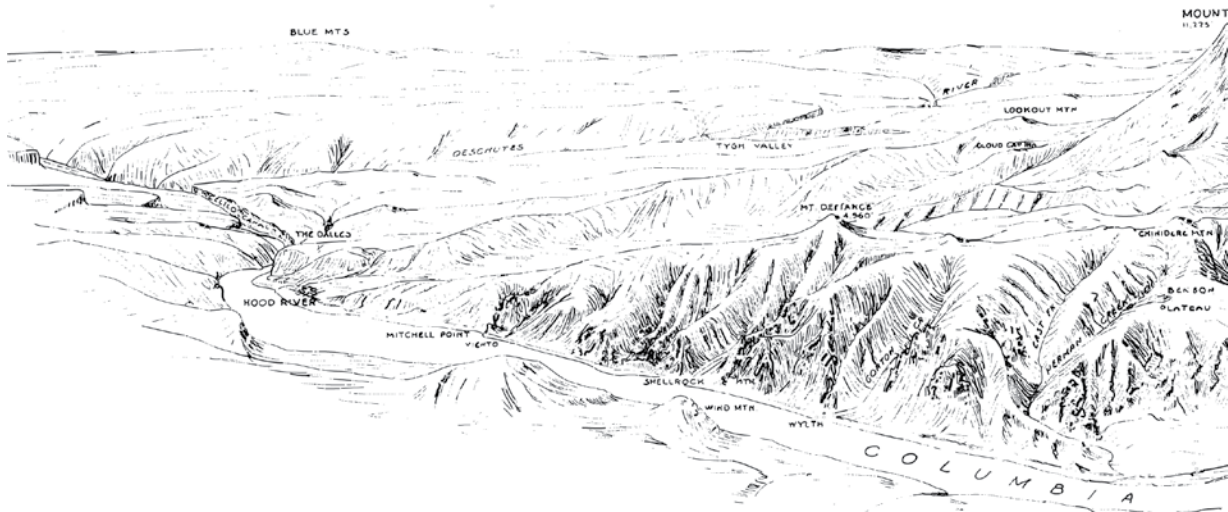

Figure 3. Columbia Gorge, adapted from USDA Forest Service Map 1916 “Columbia Gorge Park”

relict plant species.

The Columbia River is the only sea-level passage through the Cascades in the Pacific Northwest, and a major migration route for plant and animal species. The waterway has a long human history as well, as a travel route and as a major trade center pre-dating Euro-American contact. Exploration of the area by European and American fur traders began in the eighteenth century and culminated with Robert Gray’s discovery and naming of the Columbia River in 1792. Next, Lewis and Clark’s overland journey brought attention the area. Still later, nineteenth

century trappers and pioneers navigated the river for enterprise and settlement of the region.

The area of the gorge between Dodson and Hood River has a somewhat different character than the sections to the east and west. The basalt cliffs, high waterfalls, and lush fir and hemlock forests of the central Gorge gradually give way in this region to a somewhat drier climate and more open vegetation, transitioning to pine and oak forest near Hood River. The geology is characterized by steep, unstable shellrock slopes, cliffs with unstable slopes or slides below them, gravel flats, and rocky volcanic points

Figure 4. Segments of Historic highway inventoried (shown in yellow)

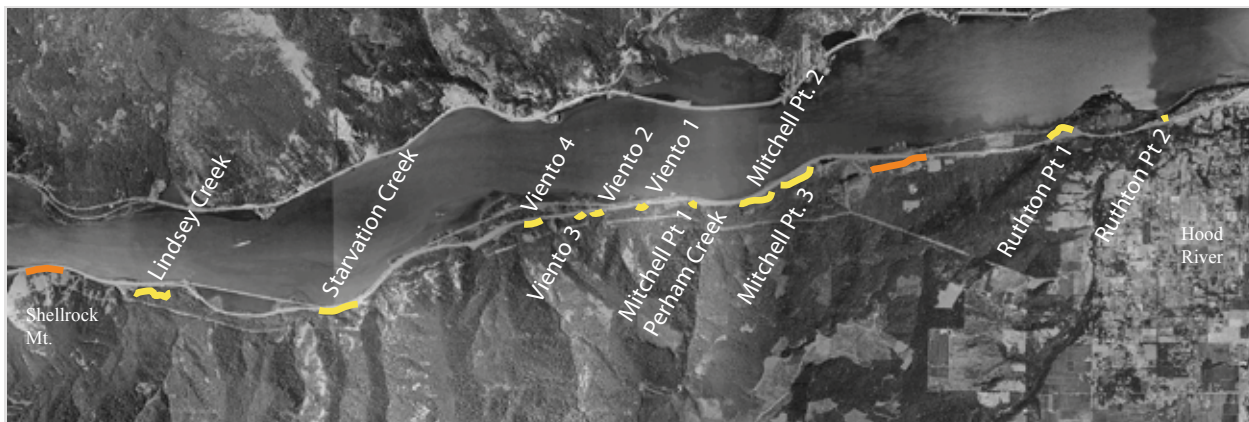



protruding into the river. These alternate rapidly within a short distance, creating a fine-grained mosaic of soils and geological conditions (Elliot 1914, Williams 1923).

Boundary description

The area of the CLI consisted of fragments of the historic highway remaining between the Shellrock Mountain (lat. 45.6919, long. -121.7436) and Ruthton Park, Hood River (lat. 45.7085, long. -121.5641), for 100 feet on either side of the approximate center line of the HCRH (Fig. 2 and 4). This amounted to a little over three miles of original historic highway alignment, in discontinuous fragments.

Relationship to the Milepost 2016 Reconnection Strategy

The segments surveyed for this inventory are located within the following sections corresponding to the Milepost 2016 Reconnection Strategy (Fig. 4):

- Segment 3 - Shellrock Mtn. Crossing

- Segment 4 - Shellrock Mtn. to Lindsey Creek
- Segment 5 - Lindsey Creek to Starvation Creek
- Segment 6 - Viento State Park to Perham Creek
- Segment 7 – Perham Creek to Mitchell Point West
- Segment 8 – Mitchell Point Tunnel
- Segment 9 - Mitchell Point East
- Segment 10 – Baumann Property to Ruthton Point
- Segment 11 - Ruthton Point to Ruthton Park

Significance of the Historic Columbia River Highway

As America’s first scenic highway, the HCRH is historically significant for its aesthetic design, and as an example of the development of early highway engineering. It is also significant as the first highway connecting the Columbia Basin with Portland and the coast. The design of the road solved major engineering challenges and was an aesthetic triumph of its time.

One of the more important consequences of

Historic Columbia River Highway: Shellrock Mountain to Ruthton Point

the highway's engineering was its influence on the National Park Service, in shaping its scenic roads. The NPS borrowed from the highway's aesthetic principle of "lying lightly on the land", as well as the style and construction of its tunnels, viaducts, and other structures.

The overall design of the HCRH was as important as the details of its construction. This includes the alignment and topography of the road and its relationship to the geology and geomorphology of the gorge. It unrolled before the driver a dynamic sequence of views, vistas, and scenic "events" such as waysides, fountains, and waterfalls. The CLI documents these important features of the highway, and helps us understand how they were constructed and how they fit into the overall experience of the road.

The HCRH is a National Historic District, a

National Register Historic Landmark District, a National Scenic Byway, and a National Historic Civil Engineering Landmark.



Mitchell Point Tunnel was a precedent for several National Park tunnels, including the Zion - Carmel Tunnel, Zion National Park. Photo courtesy of ODOT.

Chronology

Year	Event	Description
1851	Built	First wagon road portage established in the Columbia Gorge (also called the 'military road').
1882 - 1883	Built	Oregon Railway and Navigation Company constructed a water-level railroad track from Portland to The Dalles. It was the only viable alternative to steamships for getting through the gorge.
1894	Altered	High water washed out the wagon road and railroad tracks below Cascade Locks.
1908	Designed	Samuel Lancaster and Samuel Hill attended the first International Road Congress in Paris and toured Europe by auto. The design of medieval roads, particularly the Axenstrasse in Switzerland (built 1865), inspired design of the Columbia River Highway.
1912	Built	Simon Benson contributed \$10,000 for the construction of a new road across Shellrock Mountain. The road was built by Honor prisoners from the State Penitentiary.
1913	Established	Legislature approved the Columbia River Highway for construction.
1913	Established	Samuel C. Lancaster was appointed as consulting engineer in Multnomah County and assistant state highway engineer.
1913 - 1914	Built	The Columbia River Highway route was graded from Chanticleer Point to Eagle Creek.
1913 - 1914	Designed	John A. Elliott, locating engineer for the Oregon State Highway Commission (OSHC), surveyed from the Multnomah/Hood River county line to the City of Hood River; including the location of Mitchell Point Tunnel.
1913	Designed	Lancaster surveyed from Chanticleer Point (now Portland Women's Forum State Scenic Viewpoint) to Multnomah Falls and later to Eagle Creek.
1913	Established	Oregon State Highway Commission established.

Chronology

Year	Event	Description
1914	Established	Hood River County passed \$75,000 bond issue to connect the Columbia River Highway from the Multnomah County line to the City of Hood River.
1914	Established	Newport Land and Construction Company contracted to complete the Columbia River Highway sections west of Hood River.
1914	Built	Grading of three segments in Hood River County totaling 5.3 miles. (Multnomah/Hood River County line to ½ mile west of Cascade locks—1.5 miles; east of Wyeth to Shellrock Mountain—1.7 miles; and Shellrock Mountain to Viento Hill—2.1 miles.)
1914 - 1915	Built	22 miles were graded from 2 ½ miles west of Cascade Locks to the city of Hood River.
1914	Built	From Crown Point to Horsetail Falls, the construction of bridges, viaducts and the Oneonta Tunnel were completed.
1915	Established	Official opening of the highway from Chanticleer Point to the city of Hood River.
1915	Built	Construction of the Mitchell Point Tunnel completed.
1915	Established	John Yeon and Simon Benson campaigned for funds to pave the Columbia River Highway.
1915	Built	Construction of bridges and viaducts from McCord Creek to Eagle Creek.
1915	Designed	J.A. Elliot surveyed from the city of Hood River to the Hood River Wasco county line.
1916	Designed	Elliott conducted a preliminary survey from the Hood River/Wasco County line to The Dalles.
1916	Built	Warren Creek Bridge built.
1916	Built	Dedication of the Columbia River Highway (June 7, 1916) with ceremonies at Crown Point and Multnomah Falls. (Paving with Warrenite completed to Multnomah Falls at time of dedication.)

Chronology

Year	Event	Description
1916 - 1918	Built	Construction of bridges and viaducts from Ruckel Creek to Rock Creek west of Mosier, including the Hood River Bridge.
1916	Built	Lindsay Creek Bridge built.
1917	Built	Wasco County road built over Seven-Mile Hill between Mosier and The Dalles.
1917 - 1918	Built	Viento and Cascade Locks segments graded and surfaced.
1917 - 1918	Built	Ruthton Hill segment relocated and graded.
1917 - 1918	Built	Grading and macadamizing from the Multnomah/Hood River county line to City of Hood River.
1918	Built	Herman Creek Bridge, a reinforced concrete deck girder bridge 100 feet in length, was built.
1918	Built	Completion of Crown Point Vista House (Dedicated May 5, 1918).
1918	Built	Viento Creek Bridge built.
1918	Built	Road surface macadamized from Cascade Locks to the City of Hood River.
1918	Built	Gorton Creek Bridge, a 50' reinforced concrete slab structure designed by Metzger, was built. (Mile post marker 58, also from 1918, is nearby.)
1918	Built	Ruthton Point Viaduct built. Designed by Metzger, it was a fifty foot concrete curving viaduct, with one 10 foot and two 20 foot spans.
1919	Designed	Final location of the M-Rowena route surveyed by J. H. Scott, locating engineering (OSHD).
1919 - 1920	Built	Grading and macadamizing was completed from city of Hood River to Rowena. Paving was completed from Cascade Locks to City of Hood River. These sections opened to traffic in August 1920.
1919	Built	Phelps Creek Bridge built.

Chronology

Year	Event	Description
1919 - 1921	Built	Construction of bridges, viaducts and Mosier Twin Tunnels in Hood River and Wasco Counties completed. (Mosier Twin Tunnels completed in April 1921). Grading and macadamizing completed from Mosier to Rowena (open to traffic in June 1920.)
1921 - 1922	Built	Paving completed from City of Hood River to The Dalles, and was officially opened to traffic in June 1922.
1921	Established	The Columbia River Highway became part of the National Highway System as U.S. Route 30.
1922	Built	Final segment of highway at Rowena Point paved.
1922	Established	Formal dedication of the eastern paved portion of the Columbia River Highway held at the Dalles (July 2, 1922).
1925	Established	Viento State Park opened 1925. Final land acquisition in 1967.
1930	Established	Starvation Creek State Park opened in 1930 at Starvation Falls. Final land acquisition in 1960.
1932	Designed	Lancaster proposed a new water-level highway for higher speed traffic, leaving the Columbia River Highway as a scenic route.
1932 - 1969	Established	Lang State Park established by purchase and condemnation of private property. It was named for the original owner, Elizabeth Lang.
1933	Designed	Surveys for the new water-level highway ordered between Troutdale and Cascade locks.
1933 - 1938	Built	Bonneville Dam was built. Rising waters flooded the railroad tracks in 1938 and made it necessary to move sections of the Columbia River Highway.
1933	Built	The first facility improvements in State Parks were made by the CCC.
1933	Established	Wygant State Park established on 251 acres donated by Simeon and Olivia Reed.

Chronology

Year	Event	Description
1935	Built	Oregon State Highway Commission and US Army Corps of Engineers built a cut-through just east of Eagle Creek on new water-level alignment to provide passage for railroad and highway traffic.
1936	Built	Highway Bridge across Eagle Creek constructed on new water-level alignment. This was the first section of the new highway to be constructed.
1937	Built	Toothrock Tunnel on new water-level alignment opened as part of Bonneville Dam project.
1943	Established	Lindsay Creek State Park established by purchase and gift from private owners. The creek was named for John Lindsay, an 1850s settler in the area who later worked on Columbia River steamboats. The park was later expanded.
1943	Established	A picnic area along the Columbia River Highway existed at Lindsay Creek State Park until the 1960s.
1944	Established	Seneca Fouts State Park established on 150 acres given by Seneca Fouts.
1949 - 1953	Built	Water-level freeway constructed to replace the HCRH.
1949	Built	A segment of water-level freeway was built from Troutdale to Dodson.
1950	Closed	Lindsey Creek Bridge, the Viento Bridge and Warren Creek Bridge were torn down in the early 1950s.
1953	Closed	Rockfall blocked the highway between Mosier and Hood River at the mouth of the Twin Tunnels. Traffic was rerouted to Washington side until the new water-level highway opened later that month.
1953	Established	The Columbia River Gorge Commission was established.
1954	Closed	Mitchell Point Tunnel, Mosier Twin Tunnels and Oneonta Gorge Tunnel barricaded and closed to the public due to safety concerns.

Chronology

Year	Event	Description
1954		Portland attorney Frank Branch Riley wrote a letter criticizing the maintenance of the old highway as being “shabbily neglected”, which caused debate over the closing of the Mosier Twin Tunnels, Mitchell Point Tunnel and Oneonta Tunnel.
1954	Built	New water-level highway completed from Portland to the Dalles, replacing about 26 miles of the middle section of the old Columbia River Highway and fragmenting much of the remainder.
1954	Established	Vinzenz Lausmann State Park was established by gift from the Lausmann family.
1956	Built	The water-level freeway was widened and transformed into Interstate 84.
1966	Closed	Mitchell Point Tunnel destroyed.
1979	Closed	Herman Creek Bridge destroyed.
1983	Established	National Register Historic District nomination by ODOT approved by the Secretary of the Interior.
1986	Established	290,000 acre Columbia River Gorge National Scenic Area established.

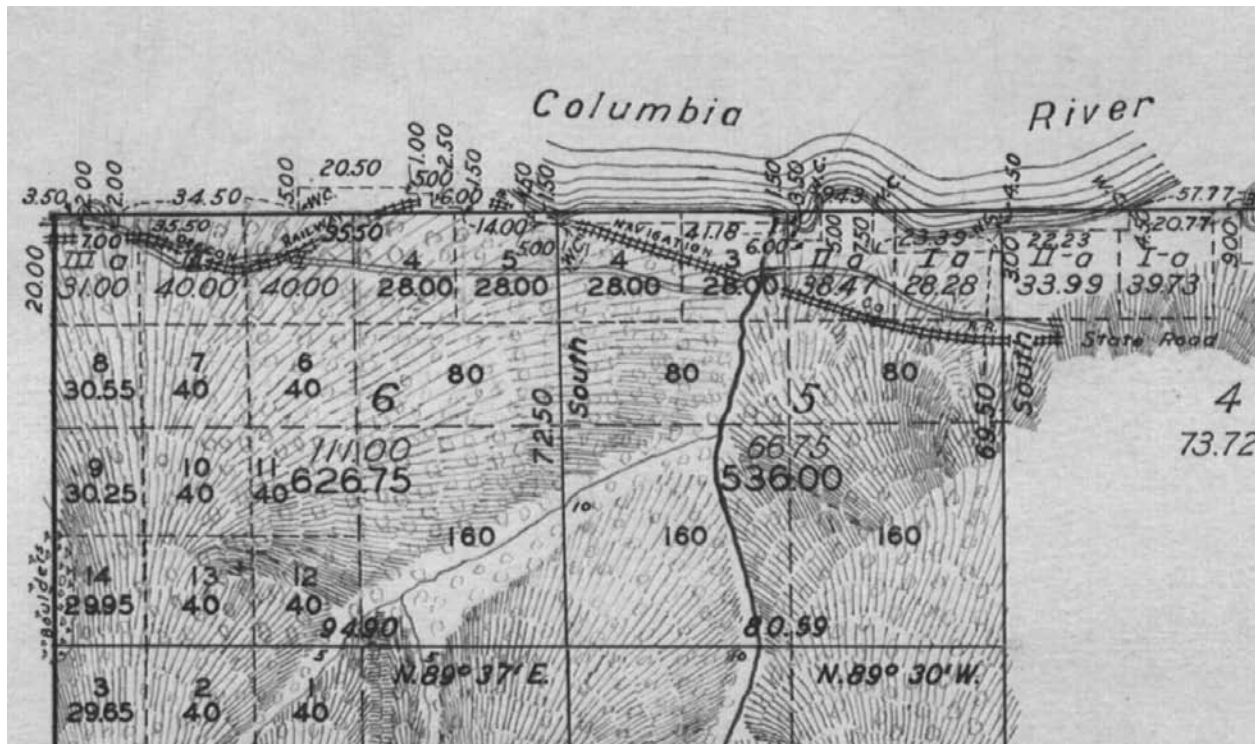

Figure 5. Survey Lindsey Creek area, 1881. Courtesy University of Oregon Libraries.

History

Early History

The Columbia River gorge has been important since pre-history as the only near sea-level passage through the Cascades in the Pacific Northwest, and as a economic and social center. The lower Columbia river, with its abundant salmon runs and wild bird migrations, was densely settled by Native Americans. Celilo Falls, at what is now The Dalles, was a trade center for Native Americans from a much larger area. When Lewis and Clark followed the Columbia to the sea, they encountered many well-established cultures centered on the river.

The earliest Euro-American settlers in the Oregon Territory used boats or rafts to navigate through the gorge. In places it was necessary to portage around large rapids, and short roads were

made for this purpose, but the geology of the gorge made road building difficult. Another transportation development of the 1850s was the introduction of steamships on the Columbia, which would continue in use well into the 20th century. Steam-ship travel still required portage around the major rapids at the Cascades (now Cascade Locks) and Celilo Falls. In 1862 the first steam locomotive, the “Oregon Pony”, was introduced to facilitate portage around the Cascades. The companies that owned these portages had a monopoly on passage on the river until the opening of the government-built locks in the 1890s.

In 1872 the State of Oregon built the first continuous road through the gorge from Sandy to The Dalles. This wagon road was known for its sharp turns and very steep grades. Much of this route was destroyed when the Oregon Railway and Navigation Company constructed a water-level track through the gorge in 1882-83. In spite of several subsequent attempts at road-building, steamboat and rail remained the main mode of transport through the gorge until the construction of the Columbia

River Highway.

Columbia River Highway Construction: 1913-22

The highway was the result of a collaboration between entrepreneur Samuel Hill and engineer Samuel C. Lancaster, who together worked to realize their vision for a scenic highway that would reveal the beauties of the landscape while also creating a modern highway connecting The Dalles with Portland. The goal was to create a drivable road, with moderate grades and a good surface, that would emulate the great scenic roads of Italy and Switzerland. The highway was begun in 1913, and completed in 1922. With the laying of the first sections it quickly became a major tourist attraction, and was heralded as “the King of Roads”.

Section of the Highway under construction. From Elliot 1914.

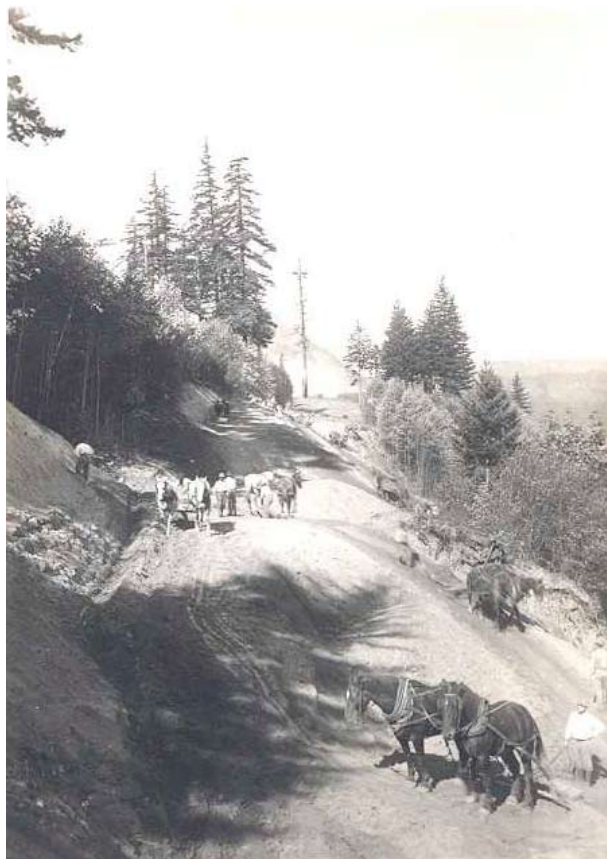

In 1914, Hood River County issued a \$75,000.00 bond to complete its section of the highway. The Newport Land and Construction Company was contracted to do the work. A student and protégé of Lancaster’s, engineer John Arthur Elliot, was hired to complete the survey and direct the construction of the highway east from the Multnomah County line. In 1913, Elliot surveyed from the Multnomah County/Hood River County line to the city of Hood River. His 1914 report details the decisions made in locating the route through this part of the gorge.

The main problems Elliot faced were the steepness and instability of the mountain slopes, and the necessity of avoiding the railroad right-of-way, which in many places took up the flat areas along the river. In his 1914 report, Elliot noted that the ground in this part of the gorge “is very broken, being composed of many slides and sinks” (Elliot 1914). Avoiding flood-prone and unstable creek mouths was another consideration.

These problems largely dictated the route and topography of the new highway. The final route connected remaining pieces of the 1872 wagon road, while avoiding its steep grades. The highway remained close to the river and the railroad, except in areas where the railroad right-of-way forced Elliot to build along the mountain slopes.

From Cascade Locks to Wyeth, the highway crossed one of the broad, wooded gravel flats along the river. Here it generally followed the old wagon road, but diverged to stay at lower elevations approaching Wyeth between Hermann and Gorton Creeks. Between Wyeth and Viento the highway closely followed the railroad, which had replaced the course of the wagon road. In the area between Shellrock Mountain and Lindsey Creek, staying close to the line of the wagon road was not possible. To avoid the railroad, the highway rose to about 200 ft. in elevation on the approach to Lindsey Creek, where cuts and fills created the roadbed along the slope of the hills. The highway then came back down to follow the railroad track along the water to Viento Hill. The railroad itself was re-routed in the area of Lindsey Creek to accommodate the highway. From Viento to Mitchell Point the highway again followed



Constructing the Hood River County section, forty eight foot rock cut and forty foot fill. From Elliot 1914.

the old wagon road “in and out among many rock points projecting into the river” (Elliot 1914), up to Mitchell Point, at an elevation of about 200 ft. At Mitchell Point, it avoided the steep ascent to the saddle above the point taken by the wagon road by the creation of the Mitchell Point tunnel, which was to become one of the scenic highlights of the route. From the east side of Mitchell Point the historic highway again followed the wagon trail for half a mile, then avoided its two railroad crossings and steep grades by approaching Ruthton Hill from the south. From Ruthton Hill the highway followed the wagon trail into Hood River (Elliot 1914). Despite the challenges, this section of the highway was constructed almost entirely between 140 and 200 feet in elevation, with a grade of five percent or less.

Grading of the Hood River county sections of the highway began in 1914, and by 1915 twenty

two miles between Cascade Locks and Hood River were completed. Mitchell Point Tunnel, the great engineering and design triumph of the historic highway, was completed in 1915, and the highway was officially opened to Hood River.

The bridges in this section were of the reinforced concrete slab, beam, or girder type. Generally, they were of a simpler design than those to the west. This may have been because they were crossing streams lower down, in less challenging areas, and so the splendid arches of, for example, the Sheppard’s Dell Bridge, were unnecessary. Again, the design of these bridges may also have been driven in part by costs, county politics, and materials shortages caused by World War I. Between 1914, when highway construction began, and 1918, when this segment was being completed, the automobile and its associated landscape and culture also developed rapidly, which may have affected the design of this part of the road.

The 1916 Lindsey Creek Bridge incorporated a simple arch design. The Warren Creek Bridge, also built in 1916, was a reinforced concrete slab bridge. In 1918 Gorton, Herman, and Viento Creek Bridges were built. The Ruthton Point Viaduct was also completed in 1918, suggesting the highway must have used the old county road through Ruthton prior to this date. Both the bridges and the viaduct were designed by Lewis W. Metzger. All of these bridges

Viento Station 1918. Courtesy of ODOT.



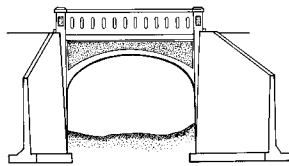

**LINDSEY
CREEK
BRIDGE**
1916 - ca. 1950

M.P. 55.75
18' OVERALL

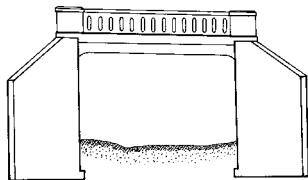

**VIENTO
CREEK
BRIDGE**
1918 - ca. 1950

M.P. 58.77
18' OVERALL

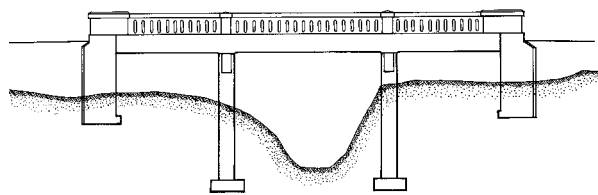

GORTON CREEK BRIDGE 1918
M.P. 52.7 50' OVERALL

except the Gorton Creek Bridge were later destroyed.

The highway was macadamized from the Multnomah County Line to Hood River in 1918 and was paved between Cascade Locks and Hood River in 1920. Construction and paving of the road from Hood River to The Dalles was completed in 1922.

In subsequent years the road was widened, new guardrails were added or replaced old ones, and repairs to retaining walls and culverts were made. However, investigation of the history of these repairs and alterations is beyond the scope of this project.

Most of the scenic attractions of the HCRH were found between Troutdale and Cascade Locks. There the dramatic western gorge scenery was complemented by the beautiful stone walls, waysides, built viewpoints, and fountains of the highway. The Hood River County portion of the road had fewer of these kinds of aesthetic details, although Elliot, under Lancaster's direction, appears to have considered the scenery in designing the route (Elliot 1914). Between Cascade Locks and Hood River the main scenic moment was Mitchell Point and its famous tunnel, one of the highway's most photographed features. The highway then took tourists on to visit the Columbia Gorge Hotel, and explore the Hood River Valley (Unknown 1915, George 1923, U.S. Tourist Service 1940).

There are a number of possible reasons for this difference in design. Costs, county politics, difficulties with obtaining materials or labor caused by World War I, differences in philosophy between Elliot and Lancaster, and differences in the landscape itself may all have played a part. The design of the automobile and how it was used also changed during this period, in turn transforming the American landscape. The curb side gas station, for example, was developed during this period (Jeckyl 1994). In any case, the highway east of Dodson came in time to be seen as a more utilitarian part of the road. In 1954, an article in the Oregonian stated that the portion of the highway from Dodson to Hood River

Figure 6. Bridges. Only one (Gorton Creek Bridge) of the original bridges in the Cascade Locks to Hood River area still stands. Drawings courtesy of HAER., 1981.

was “not part of the scenic route” (Tooz 1954). This statement may have been in part a justification for the destruction of much of this section of the highway, an inevitable result of the building of the water-level freeway in the early 1950s.

Columbia River Highway: 1922-1948

During its heyday, the HCRH not only provided a major commercial and tourist route through the Cascades, but knit together gorge towns and settlements along its path. Oral history testimony (Hadlow *et al* 2009) describes the importance of the highway to these isolated communities. Bus service on the highway connected neighbors, families, and businesses. The road itself was a community resource, around which people interacted. Wayside parks and fountains, like the frequently mentioned Viento fountain, were shared pleasures and meeting places. The road was slow, winding, and sometimes dangerous, requiring interactions with other drivers: a very different experience from a modern freeway (Hadlow *et al* 2009).

Lindsey Creek Inn, c. 1930. Courtesy of ODOT



Walkway at Mitchell Point Tunnel, 1924. Courtesy of ODOT.

The highway also provided a source of income in the services and small business that sprang up along it. Important sources of employment in the gorge were logging, the railroad, and some agriculture. The Columbia River Highway brought tourism and recreation as well. There were private campgrounds, hotels, lodges and restaurants along the road at Wyeth, Viento, Lindsey Creek, and Mitchell Point. Oral histories describe the road as dotted with restaurants and gas stations “every five

miles” (USDA Forest Service 1936, Hadlow et al 2009). These served recreational visitors, truckers, and locals (Hadlow et al 2009).

The highway in the inventoried area provided access to parks and forest recreation, fulfilling one of its important original purposes. Much of the Hood River County section of the road was protected as part of the Hood River National Forest, which maintained campgrounds and trails along the route. Four State parks (Wygant, Starvation Creek, Lang, and Viento) were established along the highway between Dodson and Hood River in the 1920s and 1930s as part of the system of highway parks and waysides, and expanded in subsequent decades. In the 1930s the Civilian Conservation Corps (CCC) was active in building trails, picnic areas and campgrounds in these parks. Lindsey Creek and Seneca Fouts State Parks were added in the 1940s.

Abandonment and Decay: 1948 -1980

As automobiles became the main mode of transport, instead of primarily a leisure amusement,

the need for a more efficient highway through the gorge adapted to larger vehicles and higher speeds became clear. A new, water-level highway was proposed by Lancaster himself as early as the 1932. Gorge communities were for the most part enthusiastic supporters of the new road. In 1936 the construction of the Bonneville dam necessitated moving the railroad and re-routing a portion of the highway, resulting in the completion of Toothrock Tunnel in 1937. Plans for the water-level road were shelved during World War II, but by 1948 a new four lane highway had been laid out. The first section, between Troutdale and Dodson, was completed by 1949. The Mitchell Point section of the HCRH was closed in 1953, and the tunnel filled in. By 1954, the new water-level highway was open.

The old Columbia River Highway between Troutdale and Dodson remained intact and used as a scenic route, while the section from Hood River to Mosier became a county access road or reverted to private ownership (Tooz 1954). The new water-level road was built over much of the historic highway between Wyeth and Hood River, leaving a number

Construction of water level highway, near Gorton Creek, 1952. Courtesy of ODOT.





Mitchell Point Tunnel filled in, c. 1950s. Courtesy of ODOT.

of disconnected, inaccessible fragments. Some short sections of the old highway became frontage roads or local streets; others were abandoned. In the late 1950s the water-level road was expanded to four lanes, and eventually became Interstate 84. In 1966 Mitchell Point tunnel was removed by blasting; the fragmented rock became roadbed for the widened water-level road.

For some towns the new highway brought improvements, while others struggled to survive. The closing of the historic highway led to the demise of the many businesses that had established themselves along it, and the new water-level road divided towns and property along its route (Hadlow et al. 2009). At the same time, the 1954 route improved connections to Portland and reduced the isolation of the gorge, bringing an even larger volume of tourists to certain areas.

The unused, isolated fragments of the old highway between Dodson and Hood River lapsed into deterioration. The road bed became overgrown with moss and shrubs, drainage structures clogged, and parts of the road washed out. Business, homes, and farms along abandoned sections of the

highway disappeared, leaving only foundations and naturalized ornamental plants behind.

Preservation and Re-Use: 1981-Present

In 1981 the National Park Service's Columbia River Highway Project inventoried almost the entire length of the historic highway and evaluated some closed portions of it for possible reuse as hiking or bike trails (Columbia River Highway Project 1981). This was followed by the nomination of the highway as a National Register Historic District in 1983. In 1986 the Columbia River Gorge National Scenic Area was established, and in 1987 the Oregon Legislature directed the Department of Transportation to reconnect abandoned and extant portions of the historic highway as a state trail for foot and bicycle traffic (ODOT 2009).

Moffet Creek Section of the Columbia River Highway State Trail. Courtesy of Friends of the Columbia River Highway.



Inventory

Objectives of the Inventory

This inventory is intended to document important characteristics and features of the sections surveyed, and to set up a database and data collection process to support a more comprehensive inventory in the future. The part of the historic highway that lies between Shellrock Mountain and Ruthton Point does not have a large number of intact historic features left, in part because it has been fragmented and abandoned for many years, and perhaps in part because the nature of the original construction. As we know from the historic road log, there were more wooden guard rails, and fewer stone features, on this portion of the road. However, other very important characteristics and features remain.

The naturalistic design of the HCRH was intended to create an experience of the road in harmony with the natural landscape. The inventory describes, in terms of specific features, this relationship of the road to the geography. It includes elements that might be overlooked or not recognized as designed. Rock cuts, for example, were made to look like natural rock, perhaps with ledges left or created for plants to grow on (Mark Davison, personal communication October 2009), and deliberately irregular surfaces. Drama was created, in some cases, by having the rock cut hang over the road. Views and vistas were framed and orchestrated by the layout of the road. This inventory identifies these features, which make up the designed character of the road, as well as remaining structures such as retaining walls, guard walls, and culverts.

Previous Inventories

There have been several previous inventories of the HCRH. However, because so little of the original historic highway is left in this section, most previous inventories have not included it. The inventories for the National Register and NHL districts focused on more intact sections to the east and west. The 1981 Columbia River Highway Project Inventory does

include parts of this section, noting some views and structures as well as the general condition of the road, but does not provide details of construction or exact locations for features. The sections have also changed over the nearly 30 years since it was done. The Federal Highway Administration's Western Federal Lands Highway Division issued a geotechnical report for the HCRH which focused only on retaining walls, and did not include this section of the highway (Evans et al. 2005). The 1987 *Study of the Historic Columbia River Highway* (Gronowski and Kloos, 1987) includes these sections but provides only an overview of their general condition.

None of these previous inventories included features related to the topography and alignment of the road, or detailed descriptions of views and vistas. This inventory looks at features of the road that are essential to its character and that have not been previously inventoried. It focuses on a section of the road for which no detailed inventory work has been done before. It provides us with a picture of the overall character of the highway and structural elements which will inform the design guidelines that are currently under development.

Inventory Methods

The inventory process included historic research, documentation and field work. Preliminary research in primary sources (for example, oral histories, historic aerial photographs and historic highway maps) and secondary sources (National Historic Landmark nomination and other documents) was used to describe the construction of the historic highway and large scale changes that have taken place in it over time, and to define important characteristics and features that communicate its history.

We used an inventory method developed for historic roads by Mark Davison and Susan Dolan for the National Park Service (NPS). Based on their methodology, we created a data dictionary of characteristics and features specific to the HCRH. These features were grouped into seven landscape

characteristics (Appendix 1). The characteristics are based on NPS standards for describing historic designed landscapes (Page *et al.*1998). They group individual features of the road into categories, such as “Buildings and Structures” or “Circulation”, that describe the organization of the landscape. We refined and standardized the descriptions of road characteristics and features for the HCRH based on our field work and previous inventories, especially the Historic American Engineering Record (HAER) drawings and data for the Columbia River Highway (HAER 1981). From the data dictionary we created a generalized data sheet for use in the field (Appendix 1).

We identified the segments to be surveyed from the maps provided in *The Historic Columbia River Highway Milepost 2016 Reconnection Projects* (Friends of the HCRH 2009) and from high-resolution aerial photos provided by the Oregon Department of Transportation. We began each segment at its western terminus, and moved to the east. We recorded a GPS latitude and longitude for the starting point for each segment of highway. Where it was not possible to get a field GPS point, we identified the start point on the aerial photograph for the segment, and estimated the latitude and longitude to the nearest 11 meters, using Google Earth.

We used a measuring wheel to record distances in feet from the start point along the approximate centerline of the historic highway. We recorded locations of features as distance from the segment start point, and offset or estimated offset from the centerline of the historic highway (to the nearest foot). It was not always possible to identify the centerline of the highway. The distance in feet from the start point of the segment to the feature became the feature identification number.

We identified and described each feature using the data forms and data dictionary developed for the historic highway. We photographed each feature and mapped it on an aerial photograph as closely as possible. The locations of features were compared, when feasible, with the historic road log (ODOT 1924) and 1939 aerial photos, to verify features as historic and to identify them. This was not always

possible, as not all features are listed on the log. Also, it was not always possible to find a known reference point on the log to measure distances from.

Inventory Results

The CLI identifies and describes 72 individual features, found in fragments that add up to about two miles of historic road. Because of time limitations, only features that were apparent (not buried or hidden) are included in the inventory. A general description of the findings in each characteristic is given below, followed by more detailed descriptions of each of the segments surveyed. The full database that accompanies this report provides detailed descriptions and photographs of every feature inventoried.

Circulation

Circulation is defined as those features, such as trails, roads, and parking lots, which determine systems of movement in the landscape. For the HCRH, circulation included the highway itself, intersecting roads and paths, trail heads along the road, and turnouts. Only fragments of the highway and its associated roads remain.

The historic highway

The original Columbia River Highway served a dual purpose. Initially, it provided access to nature and grand scenery – rivaling or outstripping that of Europe – as scenic highway, but quickly became important as the only automobile route connecting Portland to The Dalles and so to eastern Oregon and the Columbia Basin. It was also important as a local connector between small towns and farms in the gorge and the city of Portland, maintaining their economic viability.

As the practical and commercial use of automobiles increased in importance, the function of the highway also shifted, resulting in its rapid obsolescence. The scenic nature of the road was not suitable for increasingly larger and faster cars,

and heavier traffic. Lancaster himself recognized as early as 1932 the need for a more modern road. He hoped to retain the old highway as a scenic alternate through the gorge, a hope that has in part been fulfilled.

Even with the increasing commercial importance of the highway, tourism still accounted for a large proportion of the traffic on the highway between Portland and Hood River in the 1920s and 1930s. After the dramatic waterfalls and scenery between Portland to Cascade Locks, the road took visitors to Mitchell Point, and then on to the Columbia Gorge Hotel and the Hood River Valley. The highway also provided access to National Forest trails and recreation sites. The highway between Cascade Locks and Hood River connected four state parks (Wygant, Starvation Creek, Viento, and Lang), to which Lindsey State Park was added in the early 1940s. There were also many private resorts and campgrounds along this section of the road.

The original surface of the road was Warrenite, a patented paving process that was customized for the construction of the highway. The roadway was repaired, widened and repaved over the course of its active lifetime. This inventory recorded the start and end points and condition of paving along the historic highway fragments, except where debris and vegetation made it impossible to do so. Much of the pavement was buried or overgrown with vegetation. The shoulders of the road were generally filled in with vegetation encroaching on the paved surface.

Intersections and trails

There were no major intersecting roads on the highway between Wyeth and Hood River. All the intersections were short local roads leading to the railroad, the river, parks and campgrounds; Forest Service access roads; or roads into private property. Some of these remain, but most have become overgrown or were removed by the construction of the water-level freeway. There are still several trails that are associated with portions of the HCRH, notably the Mt. Defiance Trail at Starvation Creek and the Wygant Trail that crosses the Mitchell Point

section.

Turnouts

Turnouts along the HCRH were often associated with rock cuts, and were built from the excess rock taken from the faces of the cut. These turnouts were as much by-products of the construction process as circulation features. Turnouts were also found near features, such as waterfalls or trail heads, where people stopped regularly, providing parking for a few cars. A turnout might be associated with a fine view, as they would be later in NPS roads (Davis et al. 2004). The inventory identified two historic turnouts in poor condition, one of which may have been associated with a view. Others may be identified and relocated in the future from historic aerial photographs.

Topography

Topography includes the three dimensional surface and orientation of the landscape. The topography of a road is defined by its alignment, rock cuts, fill-throughs, and cut-throughs. Rock cuts and cut-and-fill areas on slopes created the bed of the road.

On the HCRH, cut and fill was minimized to avoid disturbing mountain slopes. Where necessary, it was balanced to create a half-bench. Rock cuts were sometimes shaped to achieve a naturalistic look, perhaps including areas that could be planted or allowed to re-vegetate naturally. These rock cuts could bring a sense of intimacy with the landscape or add drama to the road by bringing rock outcrop close to the roadway, in some cases even overhanging it. Rock cuts might be shaped to create aesthetically pleasing waterfalls and control how the water reached the road (Davis et al. 2004), although it is not known if this was done along the historic highway.

Fill-throughs carried the road through draws without the need of a bridge. Cut-throughs, like rock cuts, brought the landscape close to the road by taking the roadbed between two pieces of it.

Circulation

Area name	Feature ID	Feature Name	Condition	Condition Description
Lindsey Creek	1315	Intersection	Fair	Overgrown vegetation, drainage
Lindsey Creek	1132	Intersection	Poor	Overgrown vegetation
Lindsey Creek	768	Intersection	Poor	Overgrown vegetation
Perham Creek	83	Intersection	Poor	Overgrown vegetation, drainage problems
Perham Creek	83	Intersection	Poor	Overgrown vegetation
Viento 1	280	Intersection	Poor	Overgrown vegetation, drainage problems
Mitchell Pt 2	1481	Road Surface	Poor	Overgrown vegetation, 3" duff buildup, 10-20' deep washout.
Mitchell Pt 2	147	Road Surface	Poor	Overgrown vegetation, 3" duff buildup.
Viento 1	112	Road Surface	Poor	Overgrown vegetation, edges eroded, partially buried roadbed.
Viento 1	570	Road Surface	Poor	Overgrown vegetation, edges eroded, partially buried roadbed.
Ruthton Pt 1	10	Road Surface	Poor	Overgrown vegetation, surface buckled and broken in places, rockfall debris.
Ruthton Pt 1	621	Road Surface	Poor	Rockfall debris, moss, erosion, water pooling.
Mitchell Pt 2	1450	Trail	Poor	Alignment, grade, drainage problems
Mitchell Pt 2	330	Trail	Poor	Alignment, grade, drainage problems
Starvation Creek	871	Trail	Fair	
Mitchell Pt 3	1581	Trail	Good	
Lindsey Creek	450	Turnout	Poor	Overgrown vegetation
Mitchell Pt 2	807	Turnout	Poor	Overgrown vegetation
Mitchell Pt 3	1558	Turnout	Good	



Lindsey Creek intersection, abandoned road



Broken Pavement, Mitchell Creek diversion, Mitchell Point 2



Mount Defiance Trailhead, Starvation Creek



Wygant trail, Mitchell Point 2



Turnout, Mitchell Point 2

Topography

Area name	Feature ID	Feature Name	Condition	Description	Contributing
Mitchell Pt 3	473	Cut Through	Poor	Overgrown vegetation, erosion, gutters clogged	Yes
Mitchell Pt 3	210	Fill Through	Fair	Overgrown vegetation, culvert clogged	Yes
Mitchell Pt 2	1319	Rock Cut	Fair	Overgrown vegetation in gutter	Yes
Perham Creek	12	Rock Cut	Poor	Erosion slumping onto road	Yes
Lindsey Creek	282	Fill Through	Poor	Overgrown vegetation into roadway, drainage problems	Yes
Lindsey Creek	451	Rock Cut	Fair	Overgrown vegetation, erosion / rock fall onto road	Yes
Lindsey Creek	2	Rock Cut	Fair	Overgrown vegetation, rock fall onto road	Yes
Lindsey Creek	627	Rock Cut	Fair	Overgrown vegetation	Yes
Lindsey Creek	1709	Cut Through	Fair	Overgrown vegetation, erosion, drainage problems	Yes
Lindsey Creek	2000	Fill Through	Fair	Overgrown vegetation	Yes
Lindsey Creek	891	Fill Through	Fair	Drainage problems	Yes
Viento 3	050	Cut Through	Poor	Overgrown vegetation, drainage problems	Yes
Viento 1	001	Rock Cut	Poor	Overgrown vegetation, erosion, drainage problems	Yes



Rock outcrop, Lindsey Creek



Rock cut, Lindsey Creek



Rock Cut, Mitchell Point. The vegetation and piled debris at its base are signs of poor condition. Note the slide in the background.



Rock cut, slide, Perham Creek



Cut through, Lindsey Creek



Fill through, Lindsey Creek

Because so much of this part of the road has been lost, it is difficult to generalize about the overall topography. In general the road stayed close to the edge of the river and the railroad tracks, avoiding the unstable slopes above as much as possible (Elliot 1914). Between Shellrock Mountain and Lindsey Creek, Elliot was forced by the railroad right of way to go up the slope and create the road with cut and fill. The area from Lindsey Creek to Starvation Creek may have included some large rock cuts or cut-throughs as it wound around the projecting rocky points above the railroad line. However, only very short fragments of the road remain here. Some of the larger rock cuts – for example those associated with Benson Point, Mitchell Point and Ruthton Point – were lost with the construction of the I-84.

Buildings and Structures

Buildings and structures include built elements, such as culverts, retaining walls, and guard walls, that are part of the road, and those associated with the road, such as comfort stations, fountains, or built viewpoints.

Structures on the HCRH are an important part of its character and history. Along with their practical function, they visually united the road and its natural setting through their materials, design and workmanship. For example, guard walls and retaining walls, used to edge the road around rock cuts and rocky areas, were made from native stone to blend in color and character with the surrounding scenery. Retaining walls were usually crafted from native basalt, hewn and bossed to blend with the cliffs of the Gorge. The reinforced concrete bridges met the highest engineering standards of the period, while remaining sensitive to their natural setting. The design of these elements reflected principles of rustic design, incorporating arched or curving forms, simplicity, sturdiness, irregularity, and a naturalistic

Examples of types of structures. Top: guard teeth on top of retaining wall, near Sheppard's Dell. Center: Wayside fountain, near Horsetail Falls. Bottom: concrete guard rail reconstruction, Ruthton Point.





Cabin Creek culvert detail. The basalt stones on this culvert would be described as medium sized, hewn, bossed (shaped to have a convex face), laid in straight courses, dry laid with mortar around the pipe.

look.

Viaducts

Viaducts were used to carry the historic highway along cliffs or slopes, while minimizing disturbance to topography and vegetation. They were an important part of the innovative engineering of the highway, developing cliff-face road building to an extent not seen before (Dwight 1984). Two viaducts were built between Cascade Locks and Hood River, one at Mitchell Point, and one at Ruthton Point. Part of the Ruthton Point viaduct still remains, and has been restored. The Mitchell Point viaduct was destroyed along with the tunnel.

Guard Rail and Guard Wall

Guard rails and walls served to warn motorists of a steep road edge, and to keep cars on the road. Two main types of guard rail were used in the original construction of the historic highway (HAER 1981; Fig.30).

The Standard Arched Masonry Wall had a mortared rubble facing around a grout core, with a concrete cap. The design incorporated an elliptical arch for drainage. Italian stone masons reportedly

supervised the building of these walls, which were modelled after similar guard walls on European roads. Masonry guard walls were more expensive to build than wooden rails, but had low maintenance costs. Variations on this type of wall were used throughout the highway. In the 1950s, protests over the abandonment of the highway focused on the loss of these “Italian” masonry walls in particular (Portland *Oregonian* 1954). In the historic road log, “rubble masonry parapet” probably describes this type of wall.

According to the historic road log, rubble masonry parapet was used around Shellrock Mountain (not included in this inventory), for a short stretch of the Lindsey Creek segment adjacent to a rock cut, near Cabin Creek on the Starvation Creek segment, at Mitchell Point, at Ruthton Point, and in the area of Ruthton Park (Historic Road Log 1924). The locations of these walls suggest that masonry guard rail was used where there was a supply of rock available and the rail blended in with the surrounding landscape. Of the walls listed in the historic log, only the Ruthton Point wall and a heap of broken concrete and rubble along the Lindsey Creek segment, in a location roughly corresponding to the rubble masonry guard wall in the historic road log, were located by this survey. The rubble masonry

parapet at Ruthton Point has been restored.

Standard Guard Fence was a second common type of guard rail used during the early years of the highway. It was introduced in about 1920 and was in use throughout Oregon (HAER 1981). The simple white-painted post and plank design was inexpensive to construct and suitable to the rural landscape. This was the most common type of guard rail used on the Dodson to Hood River segments of the highway (Historic Road Log 1924), possibly because there was less stone here than elsewhere. No Standard Guard Fence was relocated by this survey.

Two other types of guard rail were sometimes used on the historic highway. Concrete arch and cap guard rail was used at Oneonta Gorge, Multnomah Falls, and Horsetail Falls. Another type of stone barrier was created by an extension of dry laid stone retaining walls, finished with taller coping or guard stones that projected like teeth above the road to

act as a guard rail (Figs. 27, 29). Current evidence suggests these types of rail were not used on the segments included in the Reconnection Strategy. A simple concrete guard rail was used on the Mitchell Point and Ruthton Point Viaducts. This guard rail has been restored on the Ruthton Point viaduct.

Retaining Walls

Retaining walls were used to prevent rock fall from unstable slopes above the road, and to retain the roadbed in areas of cut and fill. In general, retaining walls associated with the road were dry laid stone walls, built by Italian masons (WFLHD 2005). The stone used was taken from the nearest available source. It might be coursed or random in design, using shaped stones or rubble. Dry laid walls typically had small chink stones used to tighten small gaps between wall stones. Dry laid walls allow water



Retaining wall, viaduct and guard rail, near Multnomah Falls. The retaining wall is battered (sloped to the base), dry laid, unbossed, and laid in a random pattern. Many chink stones are missing, some can be seen.

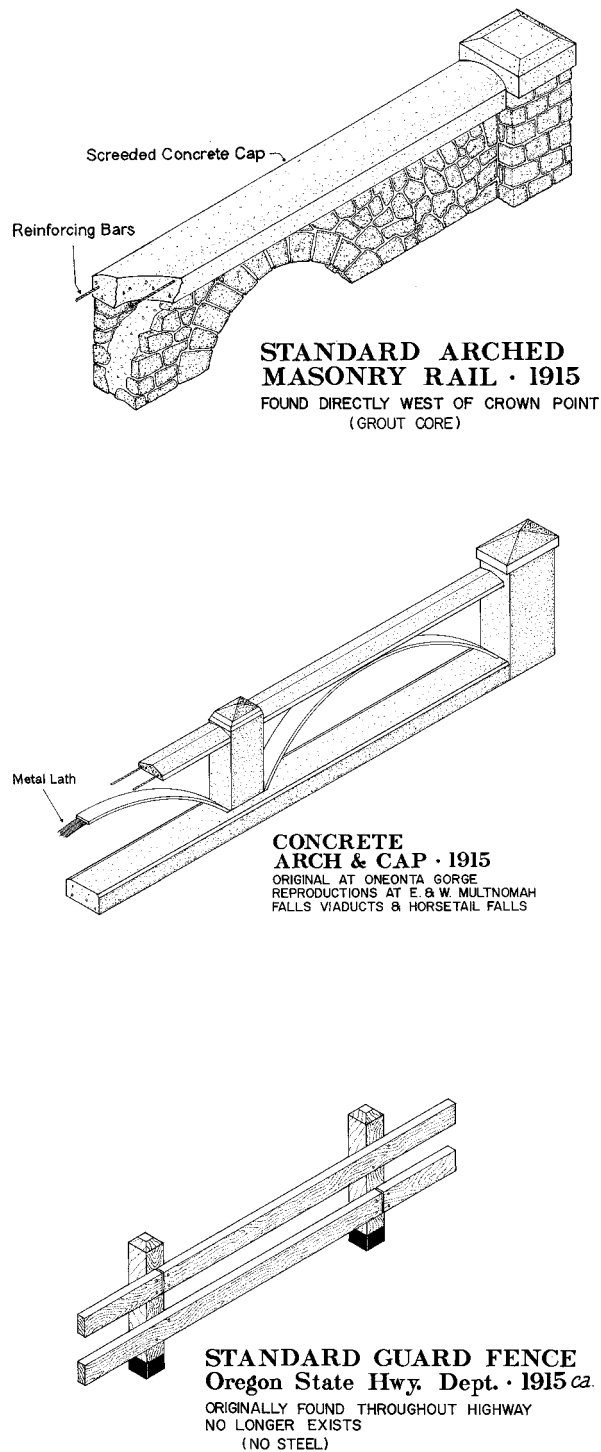

Figure 7. Guard rail types. Courtesy of HAER.

to pass through them, which decreases the hydraulic pressure on the wall. Retaining walls often were battered, or larger at the base, for stability. Later walls and wall repairs included mortar and mortar caps to hold the wall together (Figs. 28, 29).

John Elliot (1914) describes retaining walls built at Shellrock Mountain and a substantial retaining wall in the Cabin Creek section. This second wall was built to cross an old slide above the railroad right of way, “between station 700 and 725.” Elliot describes a retaining wall for the roadbed and a face wall for the uphill, mountain side at this location. The 1939 aerial photo appears to show two large retaining walls in the vicinity of Cabin Creek, one of which is in the area of a slide and may be the wall Elliot mentions. This retaining wall would have been lost with the construction of I84. Retaining walls are not recorded on the 1924 road log.

The inventory recorded a 270-foot long retaining wall in below the road on the north side of the highway, in the area of Cabin Creek. It is a typical coursed, dry laid stone retaining wall, with a mortar cap. The wall is in poor condition, with a crumbling mortar, some missing stones, and missing chink stones. It is overgrown with vegetation. The mortar cap may be a later addition.

Three other small retaining walls were found, all in poor condition. Of these, one is associated with the terrace and entry of the development associated with the road at Mitchell Point and has been patched with rubble and repaired with mortar in several places.

Culverts

Drainage structures along the historic highway included concrete, dirt, or stone gutters, catch basins, and culverts. Culverts were used to carry runoff from the gutter or ditch on the south side of the road. Where small seasonal or perennial streams crossed the road, a fill-through was often constructed and a culvert used to carry the stream under it.

Culverts varied in design from simple concrete pipes to box culverts with stone head walls and

Buildings and Structures

Area name	Feature ID	Feature Name	Condition	Description	Contributing
Ruthton Pt 2	18	Retaining Wall	Poor	Overgrown vegetation, sections collapsed	Unk
Ruthton Pt 2	10	Guard Wall	Poor	Original purpose lost	Unk
Ruthton Pt 2	20	Fence	Fair	Chain or rope for linking posts missing	Unk
Ruthton Pt 1	10	Guard Wall	Good	Modern repair	No
Ruthton Pt 1	73	Guard Wall	Good	Mortar has been patched	Yes
Starvation Creek	287	Retaining Wall	Poor	Overgrown vegetation, missing stones, mortar cap eroding	Yes
Starvation Creek	783	Culvert	Poor	Overgrown vegetation, clogged	Yes
Starvation Creek	668	Culvert	Poor	Catchbasin clogged, culvert clogged, missing stones	Yes
Viento 1	320	Retaining Wall	Poor	Overgrown vegetation, collapsed structure	Yes
Viento 1	317	Fence	Fair	A collapsed section	No
Lindsey Creek	553	Guard Wall	Poor	Rubble remains	Yes
Mitchell Pt 2	300	Culvert	Poor	Collapsed headwall, clogged	Yes
Mitchell Pt 2	1092	Culvert	Poor	Completely buried except for hole	Unk
Mitchell Pt 3	1785	Fence	Good		No
Mitchell Pt 3	299	Culvert	Poor	Buried headwall, clogged, missing stones	Yes
Mitchell Pt 3	1132	Retaining Wall	Poor	Stones missing, wall collapsing, overgrown vegetation	Yes
Mitchell Pt 3	1576	Building	Good		No
Ruthton Pt 1	298	Built Viewpoint	Fair	Overgrown vegetation blocking view, bench missing	Yes



Restored Masonry Parapet, Ruthton Point



Collapsed Masonry Parapet, Lindsey Creek



Retaining Wall, Cabin Creek Area



Retaining wall, Ruthton Park



Detail, Cabin Creek retaining wall



Culvert, rubble wall, Mitchell Point 2



Concrete culvert, concrete head wall, Mitchell Point 2



Cabin Creek culvert

detailing. Culverts that could be seen from waysides or trails were generally more elaborate than those hidden by the design of the road. These culverts were built with the same rustic design principles as other structures of the road, to blend in to the natural environment.

Drainage structures along the segments included in the inventory are almost all buried or washed out, and it was not possible to relocate them within the scope of this project. Some potentially could be relocated from the road log. The inventory found five culverts, all in poor condition. All but one appeared to be clogged, and one to have been repaired or extended with corrugated steel pipe. At Cabin Creek, the culvert is clearly designed to be seen from the path up to the falls, with a hewn, bossed basalt head wall on the inlet side, topped by a rubble wall. Another culvert in the same segment located from the historic road log includes a dry laid stone head wall. This culvert also has a stone rim on the concrete pipe.

Views and Vistas

Views and vistas were an important part of the HCRH. They were the heart of the experience of the road, and important to its alignment and routing. Lancaster wrote of choosing views of the gorge and vistas of waterfalls as “control points” for the highway. Elliot (1914) writes more frequently of the practical constraints on the Hood River County part of the road, but his inclusion of photographs of views and waterfalls in his report indicates that these were still influencing the design of this section.

Several types of views have been defined to describe the experience of roads (Davis et al 2004). *Moving views* are those seen unfolding along a stretch of the road, sometimes partly screened or interrupted by areas of vegetation. *Panoramic views* are often found at a peak in the road on a curve, and associated with a turn out or view point where motorists can stop to enjoy them. Views may be *framed* by rock or vegetation. An *axial view* is defined by the line of the road oriented toward it on a straight stretch. A *vista* is a view directed toward a

particular focal point and limited in extent, as in an opening in the forest that reveals a waterfall in the distance.

What views were most scenic or important in the early days of the road can partly be inferred from what people took pictures of at that time. Between Wyeth and Hood River, the important focal points represented in historical images are Shellrock Mountain, Wind Mountain, and Mitchell Point. Contemporary views of Wind Mountain are especially important in the Lindsay Creek segment. The distant view of Mitchell Point seen from the Viento and Mitchell Creek segments foreshadow the main event of the road, the tunnel at Mitchell Point, and provide a focal point toward which the road winds along the river. There were numerous views of the gorge and the wooded or pastoral landscape along the river, with vistas of buildings, orchards and fields opening up between wooded areas.

There were also notable views from Ruthton Point, looking down at Ruthton and the gorge to the west. The views from Ruthton Point that one can still enjoy today, were noted by Elliot (1914). The view from the Mitchell Point tunnel is of course lost, and the views preceding the tunnel are partly blocked by trees and interrupted by the chain link safety fence at the Point itself.

The landscape in the 1920s and 1930s was much more open than it is now, and many of the views and vistas are now blocked by the vegetation that has grown up since that time. There are still definable views of Mitchell Point and Wind Mountain from the existing fragments of the road. Also of interest are vistas of waterfalls and rocky draws or cliffs on the south side of the road. The inventory records four such vistas, all compromised by overgrown vegetation.

Most of these views are either gone or have been altered since the historic period. The Columbia River itself has changed dramatically, with the building of dams and dredging that have occurred since the 1930s. Farmland on the river bottom land, rapids and sandbars are all under water. Interstate 84 has replaced many of the farms and houses scattered along the road. However, important elements

Views and Vistas

Area name	Feature ID	Feature Name	View	Condition	Contributing
Ruthton Park 2	11	Panoramic View	Ruthton Point, Columbia River, agricultural fields	Good	Yes
Ruthton Pt 1	70	Panoramic View	Columbia River, framed by canyon walls into distance	Good	Yes
Starvation Creek	863	Framed View	Rock columns through trees	Poor	Unknown
Starvation Creek	620	Framed View	Cabin Creek Falls framed by rocky outcrop and draw	Fair	Yes
Mitchell Pt 3	1705	Framed View	Columbia River, I84, at Mitchell Pt end of HRCH	Fair	Yes
Mitchell Pt 3	100	Framed View	Trees frame high rocky peak in distance	Fair	Yes
Mitchell Pt 2	228	Framed View	Up a draw	Fair	Yes
Perham Creek Mitchell Pt 1	1	Framed View	Mitchell Pt from road segment (picnic area?)	Poor	Unknown
Lindsey Creek	1	Framed View	Wind Mt., I84, Columbia River	Fair	Unknown
Lindsey Creek	283	Framed View	Rocky outcrops frame draw	Poor	Yes
Ruthton Pt 1	299	Panoramic View	Columbia River	Poor	Yes



Panoramic View, Ruthton Point



Framed, axial view of Mitchell Point , overgrown with vegetation



Mitchell Point from Perham Creek



Lindsey Creek, vista up draw

of these views remain in the gorge itself and its surrounding mountains, the river, and the forests.

Small Scale Features, Archaeology, and Vegetation

Small scale features include features such as signs, seats, light poles, and mile posts. Small scale features in the inventoried section include a CCC signpost at Perham Creek, and remnants of posts or poles found elsewhere. Wooden posts still intact in the wet climate of the Gorge are unlikely to be historic.

Vegetation includes specimen trees and designed plantings associated with the road. Although plantings at waysides and specimen trees may well have been part of the design of the road, the vegetation has grown up so much that it would be difficult to identify them. Remnants of old gardens, however, are frequent along the highway, in patches of periwinkle, English Ivy, non-native roses, and other common dooryard species. These were not inventoried. A pair of beech trees (*Fagus sylvatica*) at Mitchell Point defines the barely discernible entry to a path off the old highway, but the trees are in very poor condition.

Archeology includes the remains of settlements and objects associated with the road, or found within the right of way. Foundations, old retaining walls, and piles of artifacts or rubble are examples. Most of the archeological features noted were traces of buildings that once stood along the road. Mitchell Point Segment 3 was particularly rich in these. This inventory did not detail archeological features.



Figure 8. Shellrock Mountain, 1939 aerial photograph. Extant portions of the historic alignment are shown in yellow.

Shellrock Mountain

Location (Lat.,Long.)

Start: 45.6919, -121.7436

End: 45.6902, -121.7293

Summary

Shellrock Mountain is one of the landmark features of the HCRH. Its bare slopes are covered in a deep, unstable talus formed from dioritic and basaltic rock. The relatively few trees form dark streaks down its sides.

The instability and danger of rock fall made the site a challenging one for road building. Elliot's work was further complicated by the necessity of removing a previous road built by convict labor. The earlier road was not only dangerous because of its hairpin turns and steep grades, the retaining walls were badly laid "with the apparent intention of making each rock go as far as it could" (Elliot 1914). Elliot replaced these walls with a carefully crafted stone retaining wall. The 4,000 feet of the HCRH that skirted Shellrock Mountain were notable for the dramatic talus slopes above, the impressive rock retaining walls and rubble masonry parapet guard wall along this stretch, and the proximity of the road

to the Columbia River.

This section of the HCRH was replaced by the water-level highway. Only fragments of the retaining walls and the original roadbed remain. Nevertheless, this is one of the most interesting of the abandoned segments of the highway. The mountain itself and is impressive. Remains of the rock walls and parapet along the HCRH alignment, and traces of the old military wagon road enhance the historical interest of the area.

Topography

The overall topography of this portion of the HCRH is characterized by an even grade around the toe of the mountain, below the talus slopes. There are two rock cuts that remain, each about 100 feet long and 70-90 feet high.

Buildings and Structures

Two fragments of retaining wall remain. The first is about 400 feet long near the west end of the section, built of large, ashlar and hewn basalt or diorite stone. This is about 6 feet tall, but the top of it is broken in many places. The stones vary from coursed in some areas to random in others. Fragments of wall, concrete, and of mortared rubble



Figure 9. Shellrock Mountain, west end, 2003 aerial photograph.

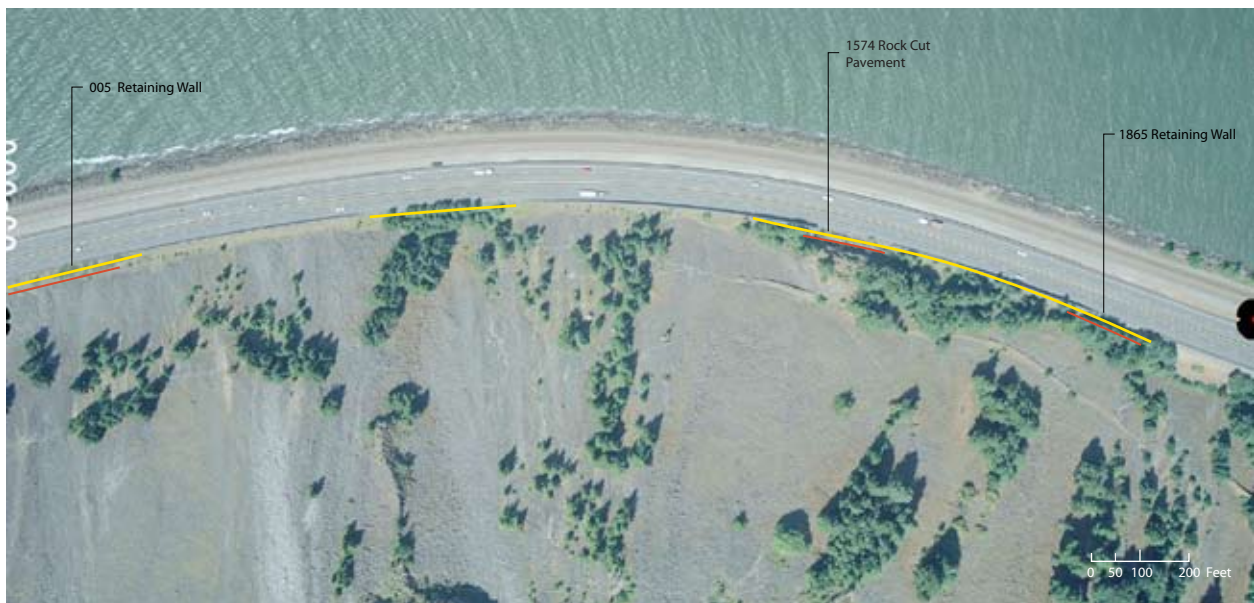

Figure 10. Shellrock Mountain, center section, 2003 aerial photograph.

Key

-  HCRH Fragment
-  Linear Feature Location
-  Feature Location

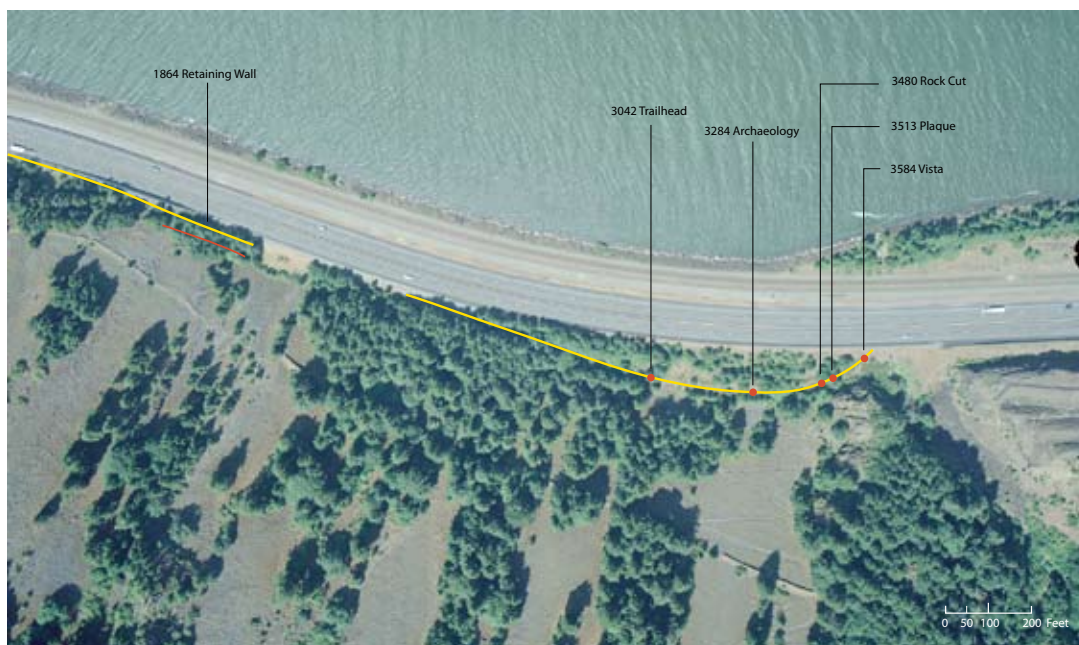

Figure 11. Shellrock Mountain, east end, 2003 aerial photograph.

masonry parapet are piled along the top of the wall, and talus has accumulated there as well. These wall fragments reveal how thick this retaining wall is, and the size of the stones used in it. The second retaining wall, located about two thousand feet east of the first, is about 150 feet long and 10 feet high, but like the first the top is broken or missing in places. The stones are hewn basalt, laid in a random arrangement with some mortar at least at the top. This second wall is buried in vegetation and overgrown with trees. It is in poor condition, but impressive nevertheless.

Circulation

Only a two fragments of HCRH pavement remain in the Shellrock Mountain section. The largest is a stretch of about 700 feet, consisting of part of the roadbed, the north edge broken off by I-84 and the south edge hidden by rock fall and vegetation. The pavement itself is buckled, patchy, and overgrown with trees, shrubs and moss. In other areas there are small patches of asphalt and heaps of asphalt piled in the roadbed. There is a trail in poor condition connecting to the military wagon road that intersects the alignment of the HCRH at its east end.

Views and Vistas

The most notable views in this section are found at its east endpoint, in the draw of Summit Creek in Lindsey Creek State Park. From this point there is a framed view of picturesque boulders, rock outcrops and a tree in center of the falls. Benson Falls, further upstream on Summit Creek, is partly concealed by vegetation. Other, contemporary views of the Gorge and I-84 can be found along the segment as well.

Small Scale Features and Archaeology

Archaeological features identified by the inventory survey include remains of concrete guard rail from the 1940s and concrete rubble by the side of the road, the original location of the plaque commemorating the “honor men” who built the road replaced by the HCRH.



Retaining wall and rock catchment, Shellrock Mountain



HCRH roadbed and rock cut, Shellrock Mountain



Broken parapet, Shellrock Mountain



Rock outcrop, Shellrock Mountain



Summit Creek draw, Shellrock Mountain



Retaining wall, Shellrock Mountain



Concrete guard post, Shellrock Mountain



Plaque site, Shellrock Mountain



View of the Columbia Gorge, I84, from HCRH alignment Shellrock Mountain

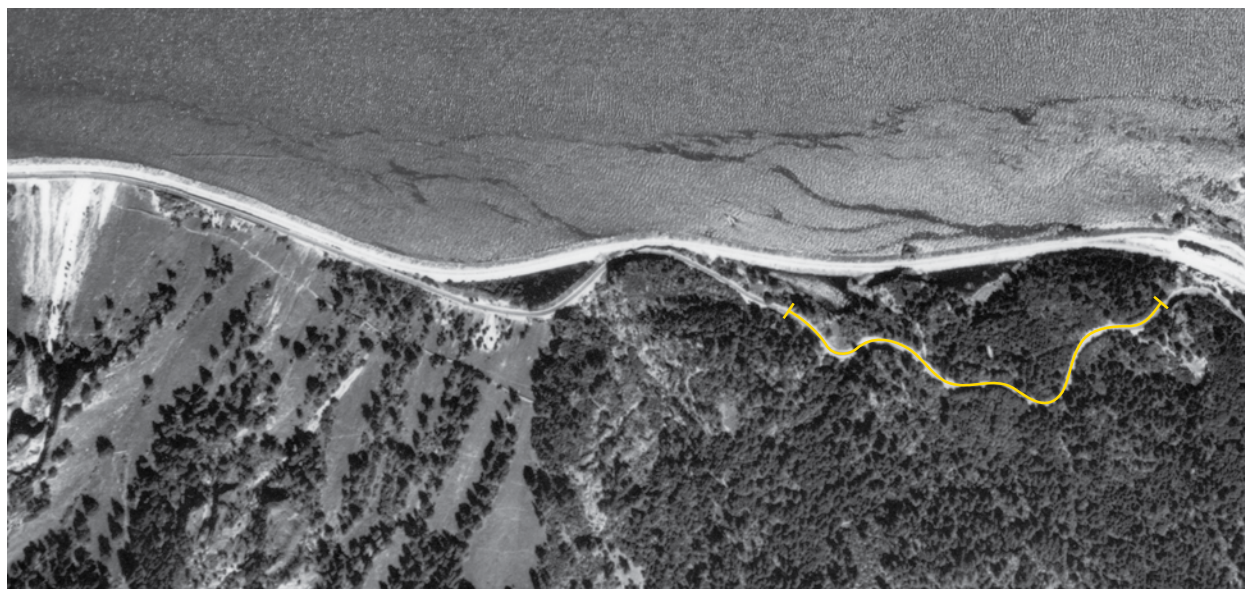

Figure 12. Lindsey Creek, 1939 aerial photograph. Extant historic highway fragment is shown in yellow.

Lindsey Creek

Location (Lat. , Long.)

Start: 45.6901, -121.5821

End: 45.6899, -121.7195

Summary

This 0.4 mile continuous segment of the HCRH is in a secluded, little used portion of Lindsey Creek State Park, at the foot of Mount Defiance. It roughly follows the 200 foot contour line around the ridge dividing Summit and Lindsey creeks. In this area the geology rapidly alternates between Columbia River Basalt outcrops and the loose light – colored rock of the Shellrock formation mixed with silt soil. The area is forested with moist, mixed conifer forest dominated by Douglas fir and western hemlock in the overstory.

The original course of the HCRH climbed straight from the edge of the river at Shellrock Mountain to round the rocky pinnacle, which now forms the western end of the highway segment

above I-84. For travelers from the east, this rock outcrop framed a dramatic view of Wind Mountain. Continuing east the highway passes through a small, moderately steep draw framed in small basalt rock outcrops and pinnacles, forming an interesting vista now overgrown with vegetation. The road then passes around another, smaller rock cut, associated with a large turn out. A small cut-through in an area of mixed soil and rock follows this. An intersecting road or trail associated with this cut-through follows the lateral ridge north, to end abruptly above I-84. This may be a remnant of the road seen on the 1939 photograph in this area .

The HCRH continues east through two broad, shallow, forested draws. A contemporary access road crosses the historic highway in the first of these, leading to I-84 to the north and to the power line and National Forest property to the south. The second large draw contains remnants of road and naturalized plants which may reflect a settlement or opening visible on the 1939 aerial photograph. The highway fragment ends just short of a large, slightly overhanging rock cut partially removed by the construction of the Interstate. Historically it then descended into the draw of Lindsey Creek to meet the railroad right of way at an elevation of about 120

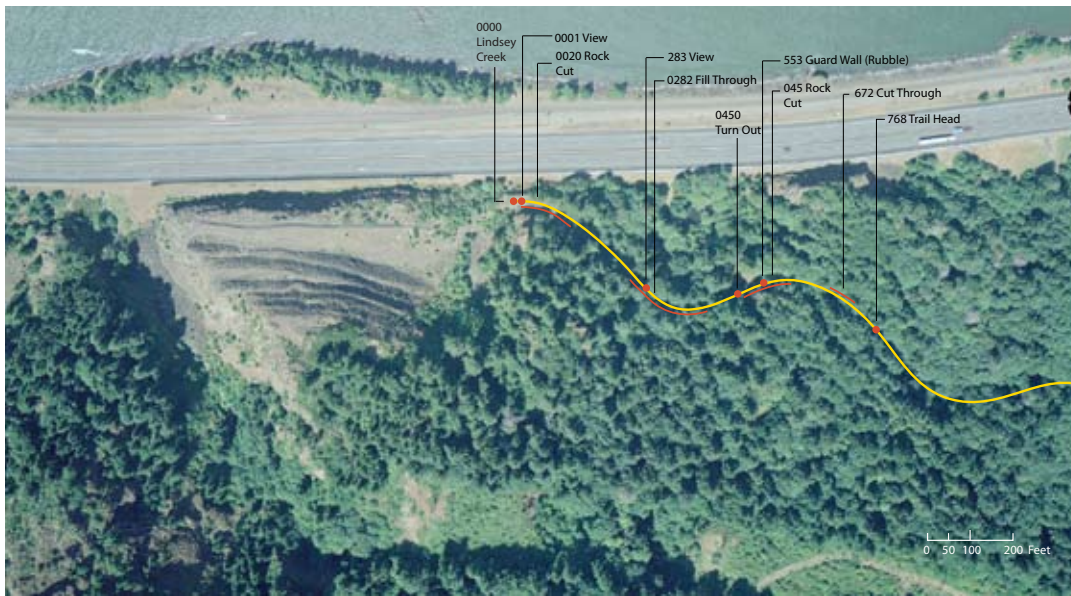

Figure 13. Map of features found in west end Lindsey Creek Segment, 2003 aerial photograph

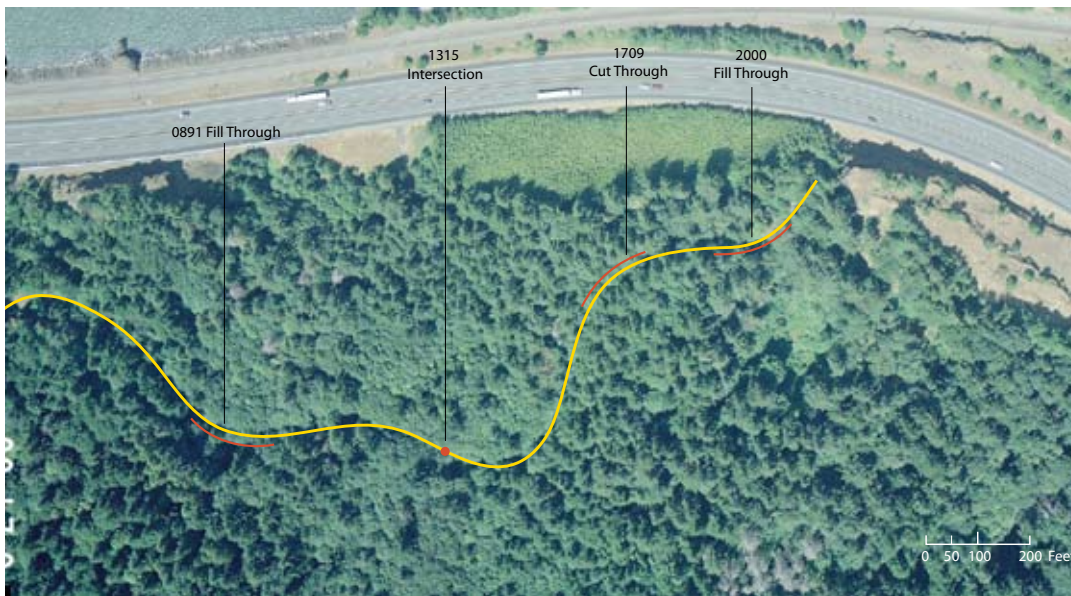

Figure 14. East end of Lindsey Creek Segment, 2003 aerial photograph

Key

- HCRH Fragment
- Linear Feature Location
- Feature Location

feet, near the Lindsey Creek Inn.

Buildings and Structures

According to the historic road log, there were several short stretches of standard guard fence in this segment, and one of rubble masonry parapet. No trace of standard guard fence is left, except a small chunk of partially burned post that may be a remnant. The remains of the guard wall were identified by the survey in 1981 as a ruin, but were not located (HAER 1981). As mapped by this survey, this wall is associated with a rock cut and turn out, in approximately the location given by the road log. It is now a heap of stones and broken concrete, and details of its design are impossible to determine. No culverts or other drainage structures were relocated in this fragment.

Topography

The rock cuts in this section are in fair condition, compromised by some minor rock fall and slides, accumulation of soil in gutters, and small trees and other vegetation along the road edge. The large rock cut at the eastern end was not evaluated as it is past the end of the fragment and inaccessible. There are three fill-throughs. Two are in fair condition, with blocked drainage structures. One is in poor condition, with blocked drainage and overgrown vegetation. The two cut-throughs in the fragment are both in fair condition. They are overgrown with vegetation and sapling trees, and one of them has formed an eyebrow of soil undercutting its top edge, compromising the stability of trees above. Both cut throughs have some slumping or rock fall into the roadbed.

Circulation

The roadbed of the historic highway is covered in a few inches of duff and moss through out the fragment. Below this layer, the pavement appears to be in good condition, with the centerline still apparent. There are three wye intersections with

short, unpaved side roads, all of which may be remnants of roads visible on the 1939 aerials. These are all in poor condition, covered in debris, overgrown with vegetation and/or washed out. A currently used graveled access road forms a tee intersection with the Historic highway. A lens shaped turnout associated with a rock cut, masonry wall and road or trail to the north is in poor condition. Its surface is covered in moss, with no evidence of pavement underneath. It is overgrown with Douglas fir and big leaf maple seedlings, and with invasive Scotch broom.

Views and Vistas

The view of Wind Mountain at the western end of the segment is in poor condition, compromised by vegetation, the concrete barrier at the end of the segment, and the Interstate below. The inventory also identified a vista to the south, up a steep draw framed by interesting rock formations. This vista is in poor condition as well, as it is overgrown with small trees.



View of Wind Mountain from east end of Lindsey Creek Segment



Fill-through, blocked drainage, Lindsey Creek Segment



Road surface, alignment, rock cut. Lindsey Creek Segment.



Cut-through, Lindsey Creek Segment. The eyebrow of this cut is compromising the trees and integrity of the slope. Fallen rocks and vegetation are also damaging.



Turn out, Lindsey Creek Segment.



Cut through, Lindsey Creek, overgrown with trees

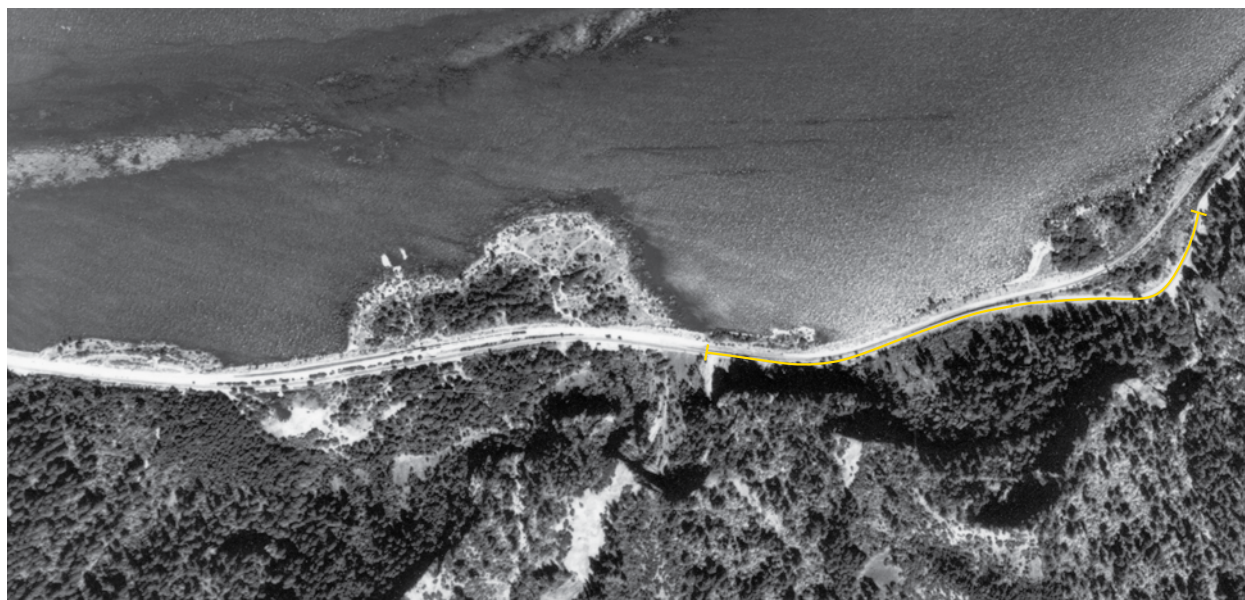

Figure 15. Starvation Creek Segment, mapped onto 1939 aerial photograph. Extant HCRH shown in yellow.

Starvation Creek

Location (Lat., Long.)

Start: 45.6881, -121.6904

End: 45.6875, -121.6458

Summary

This segment of the HCRH consists of a short segment, associated with Cabin Creek, to the west of the Starvation Creek State Park parking lot. It parallels I-84 at water level, as it did the railroad before the Interstate was constructed. The vegetation is moist, mixed conifer forest, with an overstory of Douglas fir and western hemlock and a fairly dense understory of shrubs and broad leaved riparian trees. The large Columbia River Basalt cliffs above the historic highway are close to the road near the Starvation Creek Parking lot and Cabin Falls, but are separated from it by old rock slides described by Elliot (1914). These slides have been overgrown with trees and shrubs, which have stabilized them and

obscure the geology. They reveal only glimpses of the cliffs above. More recent slides have buried parts of the roadbed. Cabin Creek crosses the historic highway, with a dramatic waterfall visible from the road.

The major features of this segment are Cabin Creek Falls and the long retaining wall below the road west of the falls. Elliot (1914) writes of the necessity of building this wall, and a corresponding face wall above the road to contain the slide. The construction of the water level road apparently removed these walls, except for the remaining piece identified here. Cabin Creek Falls was a feature of the road, as evidenced by the more elaborate culvert design, a short designed trail and turn out parking area associated with the it. Evidence from the 1939 aerial suggests that historically this area was more open, and views up to the cliffs and rock columns would have enhanced the approach to the falls. The Mount Defiance Trail terminates in this segment of the historic highway.

Buildings and Structures

The inventory recorded two culverts in this



Figure 16. Map of features, Starvation Creek Segment. Aerial photo from 2003.

Key

- HCRH Fragment
- Linear Feature Location
- Feature Location

segment. The Cabin Creek culvert was designed to be seen from the trail to the Falls, and consists of 36" concrete culvert set in a six foot wide headwall of coursed basalt stones that have been hewn and bossed, laid with mortar. Above and to the sides of the mortared headwall is a continuation and wing walls of unhewn, dry laid rubble wall. This rubble wall appears to have been repaired or modified at some time. Because of these modifications and some missing stones, the culvert is considered to be in poor condition. A second concrete culvert with basalt stone detailing around the mouth is in poor condition because it is almost entirely buried and clogged.

The retaining wall below the road is a portion of the long retaining wall built by Elliot. It is a 267 feet long dry-laid battered basalt stone wall, standing

about five feet tall. The stones are hewn and bossed, and laid in a random to semi-coursed pattern. The top layer of stones has been mortared. Now covered in moss and fern, with many missing chink stones, it is in fair condition. A contemporary wire and steel post fence runs along the top of the historic retaining wall.

Topography

There were two possible small rock cuts on either side of Cabin Falls, but it was not clear if these are created or natural rock face.

Circulation

The HCRH road surface appears to be mostly

intact, with some crumbled areas and potholes. It is covered in a thin layer of duff and mud. The gutter area along the south edge is buried in debris and overgrown with vegetation. There are two areas where slides have brought rock and mud onto the road. The historic highway pavement terminates at wheel 1207 along the centerline, near the off ramp from I-84.

Two trails intersect the HCRH in this segment. There is a the short, informal path up from the road to Cabin Creek Falls. The Starvation Creek cut-off trail also terminates in the historic highway near Cabin Creek Falls. It is a dirt trail in fair condition.

Views and Vistas

The major view in the segment is a framed vista of Cabin Creek Falls from the road. The view of the falls is framed by a towering boulder or rock outcrop. The 1939 aerial shows this area as more open than it is today; now it is overgrown with trees and vegetation. To the east of the falls is another view of rock columns, also obscured by trees.



Cabin Creek area, Starvation Creek Segment. Overgrown vegetation along road edge, slide (right, background), debris and mud build up on edges of the road surface.



Retaining wall north of Historic highway. This may be part of a longer wall. It is damaged by the ferns and other vegetation, missing chink stones.



Cabin Creek culvert. The style of this culvert suggests it was meant to be seen from a path to the fall.



Cabin Falls vista, Starvation Creek Segment



Detail, rubble headwall, Cabin Creek



Buried, clogged culvert, Starvation Creek Segment



Figure 17. *Viento Segments, 1939 aerial photograph. Extant HCRH shown in yellow.*

Viento

Location (Lat.,Long.)

Start: 45.6970, -121.6652

End: 45.6991, -121.6458

Summary

This section consists of four short fragments of HCRH, which begin just east of Viento State Park. In this area the old wagon road wound around a series of very steep rocky points jutting out into the Columbia River. The historic highway stayed close to the railroad and water level, using the course of the old wagon road around these points. As a result, most of the roadway was lost to the water-level highway, leaving only a few short “ox-bows” where the old road curved into the draws. These fragments in general have considerable damage due to the construction of the new freeway, with piles of debris, earth and old pavement common. They are badly deteriorated, overgrown with vegetation,

and washed out by flooding. Very few features were found to inventory in this section, all but one of them in the first and longest fragment.

Buildings and Structures

The roadbed east of the Viento State Park maintenance yard has what may be a very badly deteriorated battered stone retaining wall in places on its north side. Some of the stone here may simply be rubble fill forming the roadbed. There is a contemporary wire and steel post fence along the road edge, in fair condition most of its length with areas of poor condition. According to the historic road log, there was no masonry parapet in this area, only standard guard fence.

Topography

The first segment of road runs through a relatively flat area at the base of the rocky point to the east of Viento Creek. At the start of the segment is a rock cut associated with this point. It is in poor condition, with debris and boulders slumping into the roadway and vegetation filling in the road edges. The rock cut forms the north side of

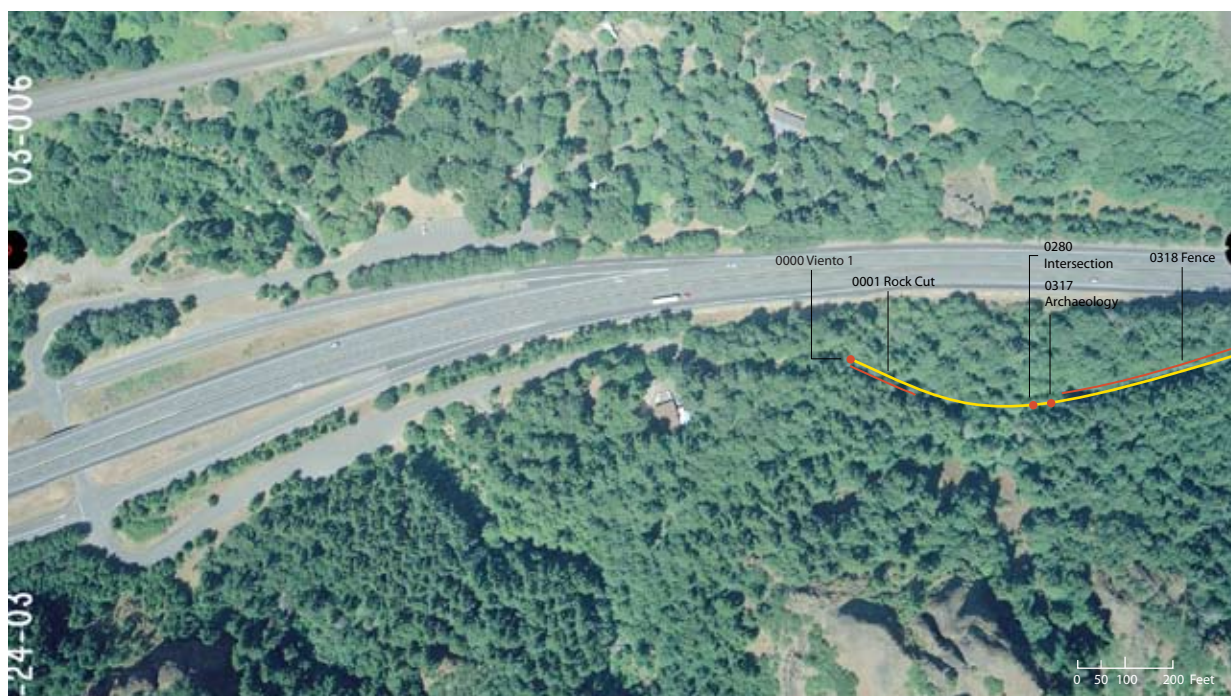

Figure 18. *Viento features, 2003 aerial photograph*

a cut-through, of which the right edge, a soil bank, is eroded and overgrown. The road then continues on fill just above the toe slope through a broad, shallow draw. The third fragment also begins at its western end with a cut-through and rock cut. This rock cut is on the north side, with a soil cut on the south side. Both are in poor condition and overgrown with vegetation.

Circulation

In this section, the historic highway pavement is cut off at the western terminus at the rock cut/cut through described above. There is 436 feet of pavement in fair to poor condition, covered in duff, mud, and gravel. Washouts due to clogged drainage structures have destroyed much the road surface from this point to the end of the segment. The roadbed has been partly cleared of mud, leaving deep banks of it on either side, so that the edge of the road could not be located.

A dirt access or logging road intersects this segment, forming a tee intersection. It connects

to the Viento maintenance yard to the east, and an unknown destination to the southwest.

The second Viento segment has a heap of old asphalt pavement and debris at its western end. The roadbed in this segment is overgrown with trees and shrubs, and covered in duff and debris. It was difficult to find the actual alignment of the road.

The third segment also had a heap of asphalt debris at its western end and was thick with trees and brush, with a badly damaged or missing road surface. The fourth Viento fragment was unusually wide, and we were unable to locate pavement. On the 1939 aerial, there is in fact an unusually wide piece of road that corresponds to the fourth Viento segment. This fragment too was overgrown with vegetation, and buried in duff. No other trails or road were evident intersecting these short fragments.

Views and Vistas



No views or vistas were identifiable from these very overgrown segments tucked back into draws.



Figure 19. *Viento segments 2 and 3, 2003 aerial photograph.*



Figure 20. *Viento segment 4, 2003 aerial photograph*

- Key
-  HCRH Fragment
 -  Linear Feature Location
 -  Feature Location



Cut through with rock cut, Viento Segment 1.



Intersection with maintenance road, Viento Segment 1



Washed out, buried road bed, Viento Segment 1. Contemporary wire fence on right.



Battered stone retaining wall/ rubble fill. Viento Segment 1.



Pile of asphalt and rubble from removed roadbed, Viento Segment 3. The roadbed in the background has buried, fragmented pavement in poor condition, overgrown vegetation.



Rock Cut, associated with cut-through, Viento Segment 3. The roadbed is piled with asphalt.



Figure 21. Perham Creek (Mitchell Point 1), Mitchell Point 2, and Mitchell Point 3, 1939 aerial photograph. Extant HCRH fragments shown in yellow.

Mitchell Point

Location (Lat., Long.)

Start: 45.6993, -121.6385 (Perham Creek)
End: 45.7037, -121.6188 (Mitchell Point)

Summary

This section contains three fragments of the historic highway between Perham Creek, on the west end, and Mitchell Point to the east. The short segment at Perham Creek is a remnant left where the historic highway curved south around a rocky point, away from the water line into the mouth of the Perham Creek draw. Historically, the highway then rose along the basalt rock shelf above the railroad, following the course of the old wagon road to Mitchell Point. At Mitchell Point the highway diverged from the wagon road over the point, going through Mitchell Point tunnel instead. There are basalt cliffs and some areas of overgrown talus

slides to the south of the road. The vegetation in this section is Douglas fir-western hemlock forest. When the inventory was being conducted, there were salmon running in Perham Creek.

As with other parts of the highway, the 1939 aerial indicates a more open and settled landscape than is present today. There were fewer trees, more cleared or farmed areas, more buildings and roads connected to the highway. An old stone sign post, in the style of the CCC, remains near the crossing of Perham Creek. Oral history testimony, naturalized plants in the area, and the 1939 aerial indicate a development of some sort here; further research may reveal what it was.

The segment of highway approaching Mitchell Point terminates on the west near a settlement of several buildings, visible on the historic aerial photograph, and now seen as a few foundations and an intersection with a dirt road that is still in use. There was a small lumber community called “Sonny” in this area during the historic highway era (Williams 1923). Sonny also appears on a 1930s Forest Service map in this approximate location. The 1939 aerial also shows settlement to the north of the highway,



Figure 22. Mitchell Point Segment 1, Perham Creek, 2003 aerial photograph

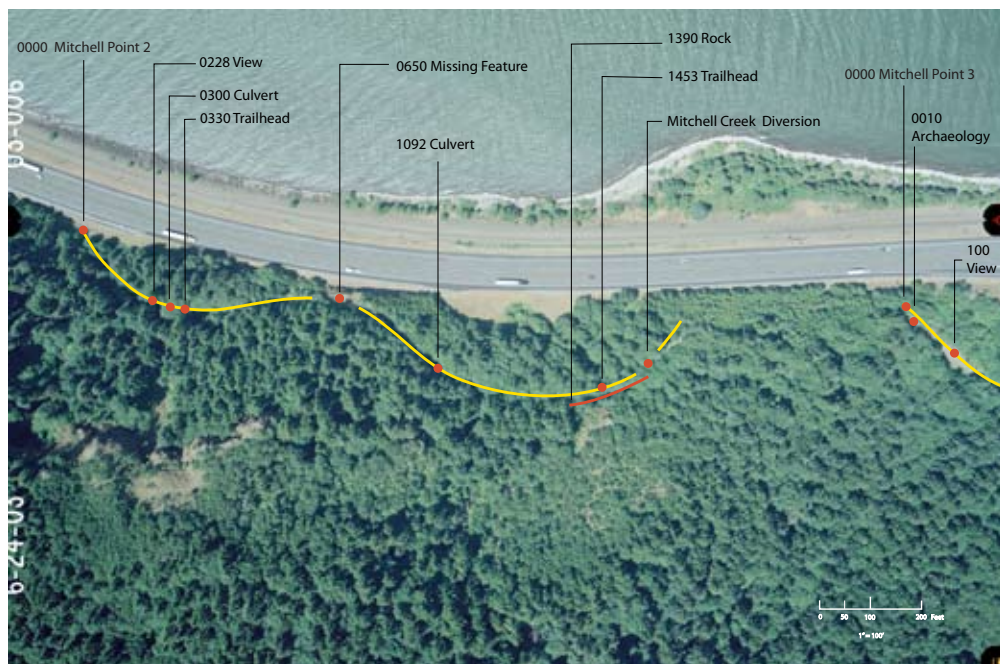

Figure 23. Mitchell Point Segment 2, west end of Segment 3, 2003 aerial photograph

Key

- HCRH Fragment
- Linear Feature Location
- Feature Location

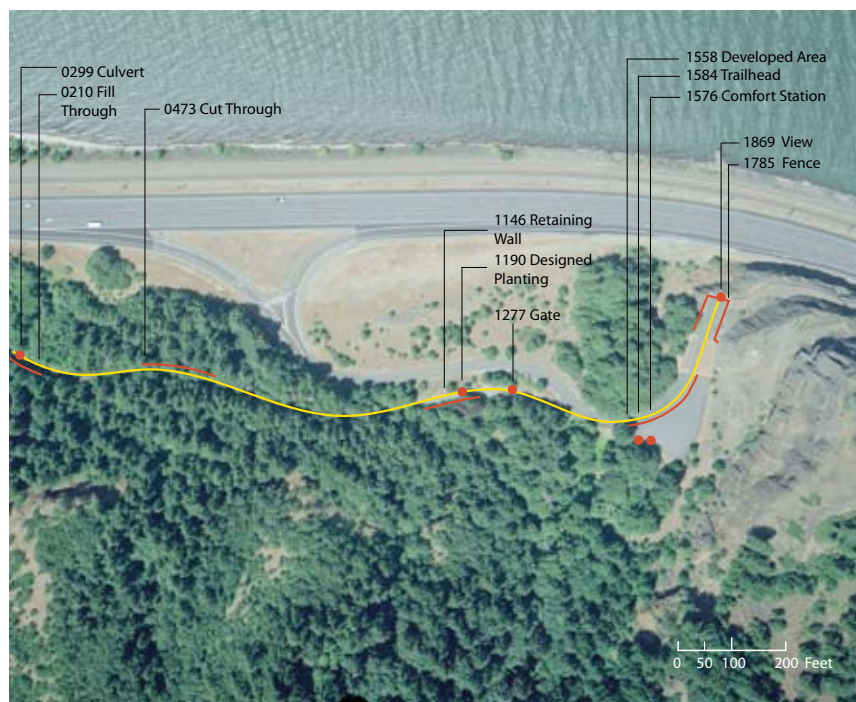

Figure 24. Mitchell Point Segment 3, 2003 aerial photograph

along the river. The roadway continues toward Mitchell Point, where all that remains of the truck stop, hotel and gas station that once stood here are a few retaining walls, rose bushes, and a pair of beech trees. Some of these are in the area of what appears, from the 1939 aerial, to have been a large garden. The present highway remnant ends in the developed area of the parking lot and overlook at Mitchell Point.

This section lies within or borders on three state parks: Wygant, Vinzenz Lausmann, and Seneca Fouts.

Buildings and Structures

The inventory relocated three culverts in the Mitchell Point section. All three are in poor condition, with clogged pipes and overgrown vegetation. One was almost completely buried. The other was a 30-inch concrete culvert extended with a steel pipe on the outlet side. A partly collapsed rubble headwall surrounded the outlet. A third

culvert in the Mitchell Point 3 segment was also partially buried, clogged and has a collapsing rubble headwall.

Topography

There are only a few rock cuts in the fragments remaining in this segment. At the west end of the Perham Creek segment is a cut in poor condition, slumping into the road and overgrown with vegetation. In the second Mitchell Point segment, on the approach to Mitchell Creek, a second rock cut about 30 feet high is in fair condition, although compromised by trees establishing at its base. In the third segment, there are no rock cuts. There is a cut-through, in poor condition with filled in gutters and overgrown vegetation. A fill-through carries the highway through a draw.

Mitchell Creek itself was diverted at some time, and cut through the remaining fragment of the Highway, leaving a short stretch of pavement and revealing the broken edge of the Warrenite

pavement above the creek. This diversion is apparent from the washout of the highway and earthworks in the area.

Circulation

The road surface of the historic highway is in poor condition or missing in much of the Perham Creek segment. A short paved road leading northwest intersects with the highway here. This road breaks off at I-84, a few hundred feet from the highway. At Perham Creek the highway is washed out.

In the middle segment of the HCRH (Mitchell Point 2) the road surface is generally covered in several inches of duff and low vegetation, and the edges of the road are damaged by trees and shrubs filling in the shoulder and gutter areas. There are stretches of intact pavement, some of which may be Warrenite. The pavement in this section has been washed out by Mitchell Creek in one area (wheel 1481 ft.), and taken up and piled on the roadbed during the construction of I 84 in another (wheel 448 – 658 ft.). There was also a lens-shaped turn-out or parking area associated with a wide shoulder, which is in poor condition and overgrown with vegetation.

A section of a popular hiking trail from Mitchell Point uses this fragment of the HCRH to connect with the Wygant Loop and Perham Creek trails. It intersects the fragment of historic highway twice. Where this trail crosses the creek, it is eroded and partially washed out. There is no bridge.

The third segment leading to Mitchell Point itself has intact pavement, covered with duff and moss, through most of its length. The centerline can be seen in some spots. The drainage areas are filled in and clogged, and in places larger vegetation is invading the roadbed and filling in the shoulders. Some remnants of old driveways or roads are apparent, overgrown with vegetation, at the western end of the segment. The end of the segment intersects with a dirt road to the south. This road is visible on the 1939 aerial photo. The segment ends in the east in a large, contemporary trapezoidal paved

parking lot at Mitchell Point, a paved and fenced view point, and a paved trail head connecting to the Mitchell Point Trail. In the Mitchell Point area, traces of old paths into the former hotel site remain visible.

Views and Vistas

During the historic period, the Viento segment provided the first distant views of Mitchell Point, whetting the interest of travellers for this scenic high point (Williams 1923). This is now a characteristic of this section, beginning with a distant view of the point from Perham Creek. The view from Perham Creek also encompasses the gorge to the west, and has potential views back up the canyon of Perham Creek itself. The middle segment (Mitchell Point 2) includes a vista associated with the Wygant Trail, up a rocky, dramatic draw, as well as a view of the gorge to the west. Mitchell Point (section 3) has at its western end a framed view of Mitchell Point, somewhat compromised by vegetation.

Vegetation and Historic Archaeology

The Mitchell Point segments have a number of areas of old foundations, traces of entry roads, and naturalized plantings. A pair of beech trees mark an old path in to what may have been a garden area at Mitchell Point, and another set of foundations marks a settlement at the west end of this segment. Naturalized rose bushes, invasive English ivy and periwinkle are also common in the third Mitchell Point section.



CCC sign post, Perham Creek



Salmon, Fall 2009, Perham Creek.



Stone wall and remnant of trail up draw, Mitchell Point Segment 2



Clogged concrete culvert, Mitchell Point Segment 2



Mitchell Point Segment 2, Wyzant trail intersection. Overgrown pavement, clogged drainage system.



Pavement edge, washout at Mitchell Creek, Mitchell Creek Segment 2



Mitchell Point Segment 3, retaining wall and settlement site from parking lot. The wall has failed and been patched with mortar and rubble.



Partially missing pavement, contemporary view, Mitchell Point Segment 2.

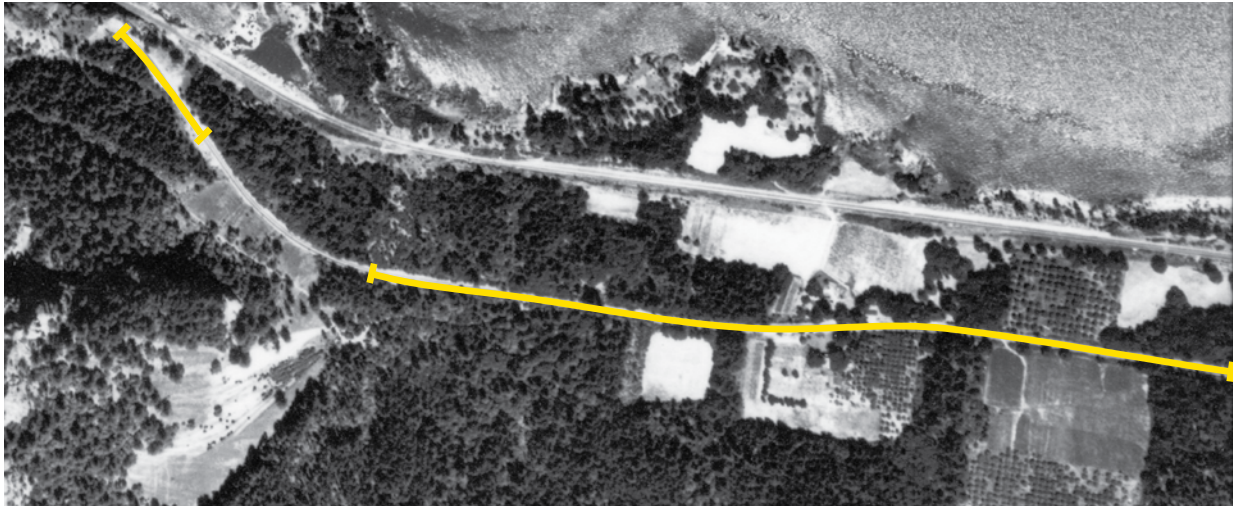

Figure 25. Mitchell Point East, 1939 aerial photograph. Extant HCRH shown in yellow.

Mitchell Point East

Location (Lat., Long.)

Start: 45.7042, -121.643

End: 45.7043, -121.569

Summary

This section is found on the east side of Mitchell Point, and includes about half a mile of Mitchell Point Drive, which follows the alignment of the HCRH and provides access to residential properties. On this side of Mitchell Point, the climate transition of the gorge becomes apparent. The vegetation here changes from Douglas fir forest to drier oak and pine.

The HCRH alignment has its west endpoint at the approximate site of the destroyed Mitchell Point Tunnel, and runs through a disused quarry. The 1870s military wagon road went through this quarry area as well, winding down from the saddle between Mitchell Point and little Mitchell Point to meet the HCRH once more. The HCRH again followed its course from this point toward Ruthton Hill (Elliot 1914). This quarry was expanded during

the construction of the water-level highway and used subsequently, creating a large, disturbed open space.

In the 1930s, this land was still primarily orchard and agricultural, surrounded by forested slopes. Some of the historic field pattern is still traceable in the present landscape, and the 1908 Locke (now Galligan) family house still fronts the road as it once did the military wagon road in the same location (Hadlow *et al.* 2009). I84 now cuts the property off from the river and replaces some of the orchards.

Topography

This short section of the HCRH has a relatively gentle profile, descending along the broad toe slope between the steep basalt cliffs to the south and the flooded bottom lands of the Columbia River. The site of the disused quarry at the high point of this section is bounded to the southwest by the dramatic silhouette and cliffs of Mitchell Point. What appears to be a small cut through in the vicinity of the 1908 Locke house may be an artifact of more recent alterations to the road. The cut on the south side of the road is in poor condition. It is overgrown with vegetation and undercut at the top. The apparent cut on the north side of the road is a dirt berm that separates the current road from a road fragment of





Historic Columbia River Highway: Shellrock Mountain to Ruthton Point



Figure 26. Mitchell Point East, west end, 2003 aerial photograph.



Figure 27. Mitchell Point East, east end, 2003 aerial photograph

Key			
	HCRH Fragment		Feature Location
	Linear Feature Location		Possible HCRH alignment

what may be the original alignment of the HCRH. This overgrown and partly buried fragment parallels the current Mitchell point drive. Patches of old asphalt can be found along it.

Buildings and Structures

The Locke family settled here in the 1880s, building a house along the old military wagon road in 1908. This 1908 house still stands and is occupied by members of the original family. A barn of even earlier construction has been moved from its original location (Hadlow *et al.* 2009). There are several newer residences and outbuildings that also front the roadway.

There are few structures remaining that are associated with the roadway. A 12” culvert with concrete head and wing walls in fair condition carries a small seasonal creek under the road.

Circulation

A portion of the alignment of the HCRH is now Mitchell Point Drive, a short well-maintained road providing access to residential property. Private, unpaved access roads intersecting the HCRH alignment lead to fields and old orchard sites.

Above the Galligan residence, a short segment of the HCRH appears to run parallel to the current road. This segment is separated from Mitchell Point Drive by a low, overgrown berm. It has patches of pavement, and what appear to be old driveways or access road connecting to it. Further research may clarify what this road fragment is. It can be traced toward Mitchell Point on the current aerial photograph.

The disused rock quarry is at the west end of the segment. This is a large, disturbed open space. The alignment of the HCRH in this area is uncertain. The military wagon road once came through this area as well, and the end of it can still be found on the southwest slopes above the quarry. At the top of the quarry fragments of pavement show where the HCRH came down from Mitchell Point Tunnel.

Views and Vistas

There is a panoramic view in both directions of the Columbia River Gorge from below Mitchell Point at the top of this segment, and a dramatic framed vista from the disused quarry site up to Mitchell Peak.



View east from west end of Mitchell Point East.



Asphalt heap, roadbed and disused quarry site, Mitchell Point East.



Possible abandoned alignment HCRH.



Vista of Mitchell Peak from quarry.



Concrete culvert headwall, Mitchell Point East.



Figure 28. Ruthton Point, 1939 aerial photograph. Extant HCRH shown in yellow.

Ruthton Point

Location (Lat.,Long.)

Start: 45.7066, -121.5821

End: 45.7085, -121.5641

Ruthton Park

Location: (Lat.,Long.)

Start: 45.7085, -121.5641

End: 45.7087, -121.5635

Summary

These two short fragments lie between Mitchell Point and the city of Hood River - “Seventy thrilling miles of pavement from the city of Portland” (Williams 1923, pg. 117). The 1920s Columbia Gorge Hotel, mentioned in most period guides as the culmination of tours of the highway, is a short way east of Ruthton Park. From here, tours would explore the Hood River Valley, a landform created by

the gradual flattening out of lava flows. These lava flows form a series of terraces above the river rising to the valley. The historic highway followed the edge of one of these terraces to connect Mitchell Point with Hood River.

Both the climate and the landscape context change east of Mitchell Point. Here it is drier and more open, with more oak and pine mixed into Douglas fir forest. Land use in this area is primarily agricultural and suburban private development, in contrast to the recreational public lands to the west. The 1939 aerial photograph reveals field outlines that are still present in the current landscape, creating a greater historical continuity of context for these sections than for the others included in this report.

Ruthton Point, once mostly orchards, has been converted to vineyard. Elliot (1914) noted dramatic views from Ruthton Hill, the site of the extant fragment. These views remain one of its attractions. The west end of this fragment is being used as a junk storage area for an adjacent landowner.

The Ruthton Park segment consists of less than 100 feet of pavement west of Ruthton Park, where the roadbed is replaced by the small parking lot of the park. The area is notable for a spectacular view

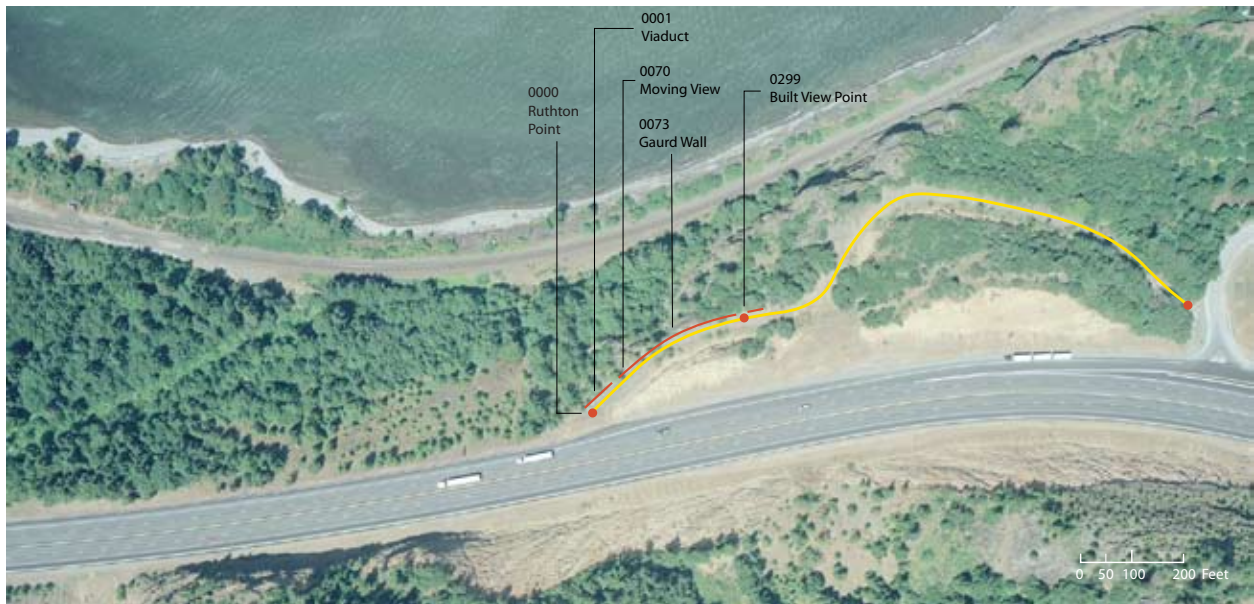

Figure 29. Ruthton Point, mapped onto 2003 aerial photograph



Figure 30. Ruthton Park, Ruthton Segment 2, mapped on 2003 aerial photograph

Key

- HCRH Fragment
- Linear Feature Location
- Feature Location



Figure 31. Ruthton Park, Ruthton Segment 2, 1939 aerial photograph. Extant HCRH shown in yellow.

of Ruthton Point from the edge of the cliff above the river.

Topography

The historic topography of both fragments in this section is obscured by I-84. The current topography of the Ruthton Point fragment consists of a large soil and rock mound or cut through dividing the segment from the freeway. The Ruthton Park fragment lies immediately below and to the north of the frontage road. Its edge is now buried under the embankment of the road above.

Buildings and Structures

The Ruthton Point fragment begins abruptly at Interstate 84. Originally, this was a rocky point. The 1939 aerial indicates rock cuts around the point, now gone. Elliot created a viaduct to carry the Highway around this point, part of which has been restored along with the associated concrete guardrail and arched rubble masonry guard wall. An “eagles nest” built viewpoint and mile markers were added during the restoration. It is not clear if there was a built viewpoint here historically. A widening of the road

visible on the 1939 aerial photograph corresponds to the reconstructed view point.

The short Ruthton Park segment has a low, battered stone retaining wall along its entire length, that is now completely hidden by fern and moss. A number of medium to large, squared boulders, which show scaling or blasting marks, are placed at more or less regular intervals along its south edge. Their provenance and date are not known. The parking lot at Ruthton Park also has a few of these boulders along its south edge, along with four concrete bollards of the style used in the 1940s (R. Hadlow, personal communication, December 2009). The stone drinking fountain in Ruthton Park is of unknown date.

Circulation

The Ruthton Point segment has only a short piece of intact pavement at its west end. The pavement for the rest of the segment is in poor condition. It is covered in dirt and gravel, patchy, or missing. The west end of the segment terminates abruptly on the shoulder of Interstate 84. The east end intersects Morton Road, which leads north to the agricultural area at Ruthton Point. This

intersection can be seen on the 1939 aerial.

in the area.

The Ruthton Park segment pavement is in poor condition. It is overgrown with moss, shrubs and trees. The edges of the roadbed are buried or have been lost to the construction of the frontage road immediately above it. This segment ends in trees and rock at just before a small seasonal drainage cuts across it, at the fenced boundary of Ruthton Park itself.

Views and Vistas

There is a distant panoramic view of the Gorge to the west from the first section of Ruthton Point. This is a moving view, seen while travelling along the road. The 1939 aerial photograph shows a series of lens-shaped turnouts along the cliff edge in this area. The built viewpoint is a recent reconstruction or addition. It corresponds to a lens-shaped shoulder widening on the 1939 aerial, partly obscured by tree canopy. The historic aerial also shows a large space, perhaps for parking, opposite this area across the road. The built viewpoint is in fair condition, with one of its benches broken off. The oaks surrounding it partially block the view. There is an informal view point equipped with a garden bench on the east end of the Ruthton Point fragment. It is a panoramic distant view of the gorge, obscured by the power line.

The cliff top area south of the Ruthton Park fragment provides a lovely panoramic view of Ruthton Point and the Columbia Gorge – perhaps one of the single most historically intact views on the highway.

Archaeology

The cliff top adjacent to the Ruthton Park fragment has a rectilinear space and stone remnants that may reflect a previous development. The 1939 aerial shows a building to the east, so this may have been parking or a garden area. There is a stone structure in the drainage between Ruthton Park and the road fragment that may have been a structure associated with the highway, or with the development



Reconstructed viewpoint, Ruthton Point



Reconstructed and repaired rubble masonry parapet, damaged and partially buried roadbed, Ruthton Point



Viewpoint, with powerlines in foreground. Ruthton Point



Archaeology, former building site, Ruthton Park, Ruthton Segment 2



Retaining wall, Ruthton Segment 2.



Edge stone, roadbed, Ruthton Park, Ruthton Segment 2



Stonework, drainage area, Ruthton Park



Drinking fountain, Ruthton Park



View, Ruthton Point from Ruthton Park

Inventory Summary

This Cultural Landscape Inventory has provided the first detailed study of the important features and construction of the Wyeth – Hood River section of the HCRH. It spot-lights the history and character of a section of the highway that has not been included in most previous inventories. It also investigates essential features, such as elements that define the topography of the highway and its views and vistas, that have never been systematically described in detail for any part of the HCRH.

The most common cause of deterioration of the highway is overgrown vegetation and buried, clogged or damaged drainage structures. Vegetation damages the road surface, topography, and drainage features, as well as blocking views and vistas. There was also catastrophic damage to the road from washouts, and debris and damage remaining from the construction of I84.

The data base provided by this inventory will be important to planning, design, interpretation and maintenance of this portion of the State Trail. It has also established a solid basis for an expanded CLI for the entire highway. If implemented on a larger scale, such a data system can streamline maintenance planning and record keeping, inform future design decisions, and assist with interpretation.

Further Research Needs

Milepost 2016 Reconnection Strategy Area

This inventory focuses only on remaining features evident along these fragments of the historic highway, and does not investigate buried or missing features. Future inventory work in this area should focus on identifying and recovering such features, especially drainage elements such as gutters, drainage ditches, catch basins, and culverts. In the future, the historic road log could be used to relocate some of these features. This work will help to stabilize the condition of the road and restore its function, as well as reveal historic features that may contribute to its

significance.

Additional work is also needed to identify views lost to vegetation. Historical photographs and aerial photography, as well as more in depth fieldwork, may reveal where some of these views may have been and how they related to each other. Current views on proposed trail projects should be investigated in relation to these historical views.

The development of the road through time, and the history of some of the features, could not be researched for this inventory. For example, the view point on Ruthton Point needs further investigation, as do changes and repairs made to culverts. A closer examination of pavement now concealed in moss and duff would inform decisions about repaving the trail.

Research should include investigation of historic land uses adjacent to the highway and historic archeology associated with the road that reflect its social history. These would inform interpretation and design of the trail, by contributing to understanding the historic highway's function and development as part of the larger landscape.

It is difficult to analyze the overall design of the road, understand Elliot's and Lancaster's intent for this section, or compare it to other sections, because so little of the highway in this area is left. There is also no comparable data for other sections. This analysis does suggest that, because of its differences in climate, geology, topography, cultural context, and design, this area had a distinct character setting it apart from other sections. More work is needed to elucidate how these elements fit together to inform this historic character. The differences between this segment of the highway and the other sections also need further research.

An Expanded Inventory for the Historic Highway

This report illustrates the value of a more detailed CLI for the entire highway. From the two or three miles of the original highway surveyed, we noted 72 features grouped into six characteristics. This is a large number of features to be found in one

of the most fragmented, deteriorated segments of the highway, and as the result of only a brief survey. Inventorying the remaining 61 miles may well reveal a thousand or more historic features, many of which have never been completely, systematically described. A more complete description of the highway would provide the kind of detailed information needed, for example, to define character areas, manage views, recognize important relationships to the land that should be preserved, and to guide restoration of structures.

Understanding how one part of the road differs from another is important to managing the road as a whole. A number of factors influence the overall feeling of the highway and its role in the landscape history of the area. These factors change over the length of the gorge, creating distinct zones along it typified by their particular combinations of natural and cultural features, and differing development through time. The delineation of these character areas can simplify and organize management decisions and planning, while reflecting as accurately as possible the variation and historic significance of the landscape.

The information in a more complete CLI would also inform a preservation philosophy, guide restoration or rehabilitation projects, and inspire the design of new elements. Finally, it would help clarify the significance of the HCRH, by providing a thoughtful basis for comparing its features and understanding its overall design in relationship to other scenic and historic roads.

If we are to manage this National Historic District to the best of our ability, we should take it upon ourselves to complete this study. It will ensure we continue to retain the character that makes it one of the most important historic roads in the country and inform guidelines that will enhance and safeguard a national treasure. This CLI sets up the database and procedures necessary to continue to the next stage.

Appendix 1.
Data Dictionary
Data Forms

DATA DICTIONARY: Historic Columbia River Highway	Landscape Characteristics:		
	1 – Spatial Organization	2 – Circulation	3 – Buildings / Structures
	4 – Topography	5 – Vegetation	6 – Views
	7 – Small-Scale Features	8 – Natural Systems	9 – Other Historic

(Object Based Landscape Characteristics)

Landscape Characteristic	Feature Name	Type	Association	Description
1 – Spatial Organization	1- Alignment			
	1- Cluster Arrangement			
	1- Sequence			
	1- Land Use			
2 – Circulation	2- Alignment	Vertical Horizontal	Developed Area Stream Crossing View Topography	Slope: < 5% 5% - 10% > 10% Style: Hairpin Reverse Curve (S-Curve) Straight
	2- Cross Section	Full Bench Half Bench	Rock Cut Graded Slope	Slope: < 5% 5% - 10% > 10% Material: Loose Rock Compacted Soil
	2- Intersection	Wye T 4-Way	Major Road Local Road Developed Area Logging Road	Destination: (next major) Material: Asphalt Dirt Gravel Direction: Topography:
	2- Turnout / Parking	Lens Bell Trapezoidal Rectangular	Developed Area View Rock Cut Passing Place Trailhead Shoulder Widening Other	Material: Paved Gravel Dirt Edge: Vegetation Concrete Curb Stone Curb Boulders Steep Slope Style: Parallel Angled Perpendicular Size: 1 car 2-5 cars 5-10 cars > 10 cars
	2- Sidewalk	Straight Curving Plaza	Developed area Bridge Viewpoint	Material: Stone Concrete Asphalt Style: Random Checkered Square Edge: Vegetated Curb Railing Stone

Landscape Characteristic	Feature Name	Type	Association	Description
2 – Circulation (cont'd)	2 - Trail	Trailhead Crossing	Developed Area Crosswalk View Draw / Valley Other (Describe)	Style: Hiking Biking Horses Material: Gravel Dirt Asphalt Edge: Vegetated Stone Stream Destination: Interpretive Regional Connection Viewpoint Campground General Recreation
	2- Road Surface	Asphalt Gravel Dirt Warrenite	HCRH Trail Logging Road Other	Material: (Same as type) Topography: (if a-typical note as separate feature)
3 – Buildings / Structures	3 – Building	Private Public	Developed Area Road Unassociated	Purpose: Comfort Station Restaurant Historic (Etc) Style: Park Standard Rustic Modern (Etc) Material: Stone Wood Metal Composite Use: Continuing Abandoned
	3 – Bridge	(Name of bridge)	Water Crossing (name) Other	Paving: Asphalt Cobbles Structure: Stone Concrete Steel Roadway: Straight Curved Arched Veneer: Stone Reinforced Concrete Wall: Ashlar Hewn Semi-hewn Unhewn Stone Size: Cobble (2-10") Sm Stone (10-20") Med Stone (20-30") Lg Stone (30-40") VLg Stone (>40") Bedrock Chinkstones: Pebble (1-2") Cobble (2"-10")

Landscape Characteristic	Feature Name	Type	Association	Description
3 – Buildings / Structures (Cont'd)	3 – Viaduct	(Insert name of viaduct if known)	Steep Slope Tunnel	Structure: Concrete Steel Other Guardwall Material: Stone Concrete Steel Wood Plan: Straight Curving Style: Coursed Random Wall: Ashlar Hewn Semi-hewn Unhewn Bossed: Yes No Stone Size: Cobble (2-10") Sm Stone (10-20") Med Stone (20-30") Lg Stone (30-40") VLg Stone (>40") Bedrock Chinkstones: Pebble (1-2") Cobble (2"-10")
	3 – Retaining wall	Stone Reinforced Concrete Gabions	Road Trail	Plan: Straight Curving Style: Coursed Random Rubble Wall: Ashlar Hewn Semi-hewn Unhewn Bossed: Yes No Battered: Yes No Stone Size: Cobble (2-10") Sm Stone (10-20") Med Stone (20-30") Lg Stone (30-40") VLg Stone (<40") Bedrock Chinkstones: Pebble (1-2") Cobble (2"-10")
	3 – Fence	Wood Steel W-Rail Chainlink Standard Guard Fence Concrete Posts Wire	Road Trail Developed Area	Plan: Straight Curving Height: < 1'6" 1'6" - 2' > 2' Style (post and stringer): Hewn Log Milled Timber Metal

Landscape Characteristic	Feature Name	Type	Association	Description
3 – Buildings / Structures (Cont'd)	3 – Culvert	18" pipe 24" pipe 30" pipe 36" pipe 48" pipe 60" pipe Box culvert Drop inlet	Fill-Through Perennial Stream Seasonal Stream General Drainage Gutter	Culvert Material: Corrugated Steel Concrete Plastic Wall: Rubble wall Mortared Stone Drylaid stone Concrete Headwall: Mortared Stone Drylaid stone Concrete Wingwalls: Yes No Stone Size: Cobble (2-10") Sm Stone (10-20") Med Stone (20-30") Lg Stone (30-40") VLg Stone (>40") Bedrock Chinkstones: Pebble (1-2") Cobble (2"-10") Waterflow: Inlet Outlet
	3 – Guard Wall	Single Stones Stone Reinforced Concrete	Road Trail Retaining Wall Viaduct	Plan: Straight Curving Style: Coursed Random Rubble Buried Concrete bollards w/ stone cap Wall: Ashlar Hewn Semi-hewn Unhewn Bossed: Yes No Stone Size: Cobble (2-10") Sm Stone (10-20") Med Stone (20-30") Lg Stone (30-40") VLg Stone (>40") Bedrock Chinkstones: Pebble (1-2") Cobble (2"-10")

Landscape Characteristic	Feature Name	Type	Association	Description
3 – Buildings / Structures (Cont'd)	3 - Built Viewpoint	Mortared Stone Reinforced Concrete Dry laid Stone Fence	Road Trail Turnout	Plan: Straight Curved Style: Coursed Random Rubble Wall: Ashlar Hewn Semi-hewn Unhewn Bossed: Yes No Stone Size: Cobble (2-10") Sm Stone (10-20") Med Stone (20-30") Lg Stone (30-40") VLg Stone (>40") Bedrock Chinkstones: Pebble (1-2") Cobble (2"-10")
4 – Topography	4 – Rock Cut	Battered Vertical Overhang	Road Trail Building Structure	Style: Smooth / Geometric Planes Naturalistic Vegetation: Yes No
	4 – Cut Through	Rock Cut Soil	Road Trail	Slope: Battered Vertical Style: Smooth / Geometric Planes Naturalistic Vegetation: Yes No Plan: Straight Curved
	4 – Fill Through	Rubble Stone Soil	Draw / Valley Wetland	Plan: Straight Curved
	4 – Berm	Dirt Rubble	Road Trail	Use: Designed (Deliberate Barrier) Debris Build-up
5 – Vegetation	5 – Designed Planting	Natives Non-Natives Mix	Developed Area Agriculture / Grazing Park Garden Orchard	Main Species: (List) Edge: Fence Planting Bed Curb Natural Surroundings Other Style: Formal / Ordered Naturalistic
	5 – Plant Association	Forest Shrub Field Meadow / Grassland	Disturbance Waterbody Typical	Main Species: (List) Edge: Fence Water Forest Other

Landscape Characteristic	Feature Name	Type	Association	Description
5 – Vegetation (Cont'd)	5 – Specimen Tree	Native Non-Native	Developed Area Turnout Road Trail Bridge Gateway	Species: (Name)
6 – Views / Vistas	6 – Panoramic View	Stationary Moving	Developed Area Road Turnout Built Viewpoint Trailhead	Angle: Low High Edge: Cliff Vegetation Rock Outcrop Structure Wall / Fence (see 3) Vegetation: Filtered Open View: (Describe subject)
6 – Views / Vistas (Cont'd)	6 – Framed View	Moving Stationary	Developed Area Road Turnout Built Viewpoint Trailhead	Length: Close Distant Aperture: 0 – 80' 80' – 200' >200' Angle: Low High Edge: Vegetation Rock Structure Wall / Fence (see 3) Vegetation: Filtered Open View: (Describe subject)
7 – Small-scale	7 – Column	Stone Concrete Wood	Developed Area Turnout Trailhead Viewpoint	Style: Coursed Random Rubble Buried Concrete bollards w/ stone cap Wall: Ashlar Hewn Semi-hewn Unhewn Bossed: Yes No Stone Size: Cobble (2-10") Sm Stone (10-20") Med Stone (20-30") Lg Stone (30-40") VLg Stone (>40") Bedrock Chinkstones: Pebble (1-2") Cobble (2"-10")
	7 – Sign	Wood Stone Concrete	Developed Area Turnout Trailhead Viewpoint	

Landscape Characteristic	Feature Name	Type	Association	Description
7 – Small-scale (Cont'd)	7 – Fountain	Mortared Stone Concrete	Developed Area Turnout	Style: Coursed Random Rubble Buried Wall: Ashlar Hewn Semi-hewn Unhewn Bossed: Yes No Stone Size: Cobble (2-10") Sm Stone (10-20") Med Stone (20-30") Lg Stone (30-40") VLg Stone (>40") Bedrock Chinkstones: Pebble (1-2") Cobble (2"-10")
	7 – Gate	Wood Metal Wire	Road Trail Developed Area	
	7 – Fence	Wood Steel W-Rail Chainlink Standard Guard Fence	Road Trail Developed Area	Plan: Straight Curving Height: < 1'6" 1'6" - 2' > 2' Rail: Hewn Log Milled Timber Metal
	7 - Gutter	Concrete Stone Dirt	Road Trail Parking	
	7 - Post	Wood Concrete Metal	Road Trail Parking Building	Mile marker
8 – Natural Systems	8 – Geology			
	8 – Hydrology	Creek Pond Wetland Waterfall River	Seasonal Perennial	
	8 – Microclimate			
	8 – Geomorphology	Valley Draw Ridge Rock outcrop Cliff Ruins		
9 – Other Historic	9 – Archaeology		Road	Material:
	9 – Foundation			

HRCH	Landscape Characteristic: <i>(Drop down menu)</i>				
	1 – Spatial organization		2 – Circulation		3 – Buildings / structures
	4 – Topography		5 – Vegetation		6 – Views
	7 – Small Scale Features		8 – Natural Systems		9 – Other Historic
AREA Name:	Feature Name: <i>(Drop down menu)</i>				
Project: CLI	1 – Alignment 1 – Cluster Arrangement 1 – Sequence 1 – Land Use		2 – Alignment 2 – Cross Section 2 – Intersection 2 – Turnout/Parking 2 – Sidewalk 2 – Trail 2 – Road Surface		3 – Building 3 – Bridge 3 – Viaduct 3 – Retaining wall 3 – Culvert 3 – Guard wall 3 – Fence 3 – Built Viewpoint
	Feature Name:	4 – Rock cut 4 – Cut Through 4 – Fill Through 4 – Berm		5 – Designed Planting 5 – Plant association 5 – Specimen Tree	
Feature ID #:	7 – Column 7 – Sign 7 – Fountain 7 – Gate 7 – Gutter 7 – Post		8 – Geology 8 – Hydrology 8 – Microclimate 8 – Geomorphology		9 – Archaeology 9 – Foundations
Photo #s:					
Left / Right	MP begin – MP end	Offset	Height	Length	Depth/Width
Type:			Association:		
Description:	(Material, Style, Use, Aperture, etc...see master list)				
Condition Description:					
Condition: G / F / P	Contributing: Yes / No / Unk	(if N) Compatible: Yes / No	Construction Date:	Source:	
Other Notes:					
Completed By:			Date:		

Bibliography

-
- Alt, David D. 2001. *Glacial Lake Missoula: and its humongous floods*. Missoula, Mont: Mountain Press Pub.
- Alt, David D., and Donald W. Hyndman. 1978. *Roadside geology of Oregon*. Missoula, Mont: Mountain Press Pub. Co.
- Bullard, Oral. 1982. *Lancaster's Road: the historic Columbia River Scenic Highway*. TMS Book Service Beaverton OR
- Columbia River Highway Project. 1981. Columbia River Highway Inventory. Copy of inventory cards completed by Dianne Ochi and others, Oregon Department of Transportation archives, Salem, OR.
- Department of the Interior, National Park Service. Columbia River Highway National Register Nomination Form. Retrieved January 10 2010 from <http://www.oregon.gov/ODOT/HWY/HCRH/docs/nomination2.pdf>
- Department of the Interior, National Park Service. Columbia River Highway National Historic Landmark Nomination. Manuscript, ODOT archives, Portland OR.
- Davis, Timothy. 2005. *Landscape Lines 16: Historic Roads*. U.S. Department of the Interior National Park Service, Washington D.C.
- Davis, T., T. A. Croteau, et al. (2004). *America's national park roads and parkways : drawings from the Historic American Engineering Record*. Baltimore, Johns Hopkins University Press.
- Elliot, J.A. 1914. *Report on Columbia Highway Hood River County*. Oregon Department of Transportation Archives, Salem OR.
- Evans, Gary L. and George Fekaris. 2005. *Geotechnical Assessment Historic Columbia River Highway Retaining Wall Inventory*. Western Federal Lands Highway Division Geotechnical Report 15-05
- Friends of the Historic Columbia River Highway and the Columbia River Highway Advisory Committee. 2009. *The Historic Columbia River Highway Mile Post 2016 Reconnection Projects*. Oregon Department of Transportation. Salem Oregon
- George, MC. 1923. *The Columbia River Highway Booklet. Through the Gorge of the Columbia River A Guide with Descriptions, Maps, and Views from Portland to the Dalles*. James Kerns and Abbot. Portland
- Gronowski, Nancy H. and Jeannette Kloos. 1987. *A Study of the Historic Columbia River Highway*. Oregon State Parks and Recreation Department, Oregon Department of Transportation.
- Hadlow, Robert W. , Amanda Joy Pietz. 2009. *Historic Columbia River Highway Oral History Report*. Final Report SR 500-261. Oregon Department of Transportation Research Section, Salem, OR.
- Huntress, Betty. 1950. *The Old Road and the New*. The Highway Magazine January 1950 pp. 14-17.

Jakle, J. A. and K. A. Sculle (1994). *The gas station in America*. Baltimore, The Johns Hopkins University Press.

Kloos, Jeannette. 2006. *Historic Columbia River Highway Master Plan*. Oregon Department of Transportation, Portland, Oregon.

Lancaster, Samuel. 1916. *The Columbia, America's Great Highway*. Reprinted 2004 Schiffer Publishing Limited Atglen Pennsylvania

Mid-Columbia Chamber of Commerce. (1948). Memorandum on relocation and modernization of Columbia River Highway, submitted to the Legislative Interim Committee...for the Study of Highway, Road and Street Needs, Revenue and Taxation. The Dalles, Or.

Merriam, Lawrence C. 1992. *Oregon's Highway Park System 1921-1989: An Administrative History*. Oregon Parks and Recreation Department, Salem OR

Ochi, Dianne. 1981. *Columbia River Highway Options for Conservation and Reuse*. Columbia River Highway Project. Cascade Locks, Oregon

Page, Rober R., Cathy Gilbert, and Susan A. Dolan. 1998. *A Guide to Cultural Landscape Reports*. US Department of the Interior National Park Service. Washington DC

Page, Robert, Lynda Frost, Daniel Gallagher, and Lori Tolliver. 2001, *Cultural Landscape Inventory Professional Procedures Guide*. U.S. Department of the Interior National Park Service, Washington D.C.

Portland Chamber of Commerce (Or.) and Kilham Stationery and Printing Company. (1923). "Portland, Oregon : featuring the Columbia River Highway". [Portland, Or.], Portland Chamber of Commerce Kilham Stationery & Print. Co.).

Routledge, F. A. (1916). Map and guide of the Columbia River Highway. Portland, Or., F.W. Baltes and Company : The J.K. Gill Company,

Scenic Tours Company. (1916). *Columbia Highway tour : Portland, Hood River, The Dalles*. Portland, Or., The Scenic Tours Company.

Smith, Dwight A. 1984. Columbia River National Historic District. Nomination of the Old Columbia River Highway in the Columbia Gorge to the National Register of Historic Places. Oregon Department of Transportation.

Tyrrell Trips Co. Inc. and Cross & Dimmitt (Firm) (1930). Columbia River Highway : America's greatest and most scenic drive from Portland, Oregon. [Portland, Or.], Tyrrell Trips Co.

Tooze, Leslie. 1954. *Gorge Lovers Deplore Ecllipse of Scenic Road: Age Demands Utilitarian Route*. The Oregonian Tuesday December 7 1954 pg 12

University of Oregon Department of Landscape Architecture. 1994. *Historic Landscape Documentation, Analysis, and Design. Historic Columbia River Highway, Tanner Creek to Eagle Creek*. Manuscript ODOT archives.

Unknown. 1915. Points of Interest along the Columbia River Highway from Multnomah Falls to the Dalles. Multnomah Hotel, Portland OR. Manuscript. Special Collections, Oregon Collection, Knight Library, University of Oregon, Eugene OR.

Unknown. 1931. S.C. "Lancaster urges fight to save highway." Oregon Journal 9 April 1931 pg 6

Unknown. 1934. "New Route Mapped for Gorge Highway". Oregonian 11 February 1934 sect. 1 pg 1

Unknown. 1938. "New Fast Route Asked for Gorge". The Oregonian Friday June 3 pg 4

USDA Bureau of Public Roads. 1920. "Substantial and Attractive Guard Rail on Oregon Road". Public Roads vol.2, no.3. pp 9-10.

United States Tourist Service. 1940. "Guide to the Columbia River Gorge Mt. Hood Loop and the famous Columbia River Scenic Highway and Bonneville Dam". Portland Oregon.

USDA Forest Service, Mount Hood National Forest. 1936. Map of Mount Hood National Forest.

USDA Forest Service. 1916. Columbia Gorge Park Map.

United State Surveyor Generals Office 1884. Township 2 N Range 9 E of the Willamette Meridan General Land Office Survey Map. Accessed October 2009 at http://libweb.uoregon.edu/map/GIS/Data/Oregon/GLO/Quadrant_4.htm.

Warren Brothers Company (Boston Mass.) (1923). *The Columbia River Highway, Oregon*. [S.l., Warren Brothers Company?

Williams, Ira and John Elliot Allen. 1991. *Geologic History of the Columbia River Gorge, as interpreted from the historic Columbia River Scenic Highway*. Oregon Historical Society Press, Portland.